

Mathematics

Class Six

$$a^m \cdot a^n = a^{m+n}$$

$$\frac{a^m}{a^n} = a^{m-n}$$

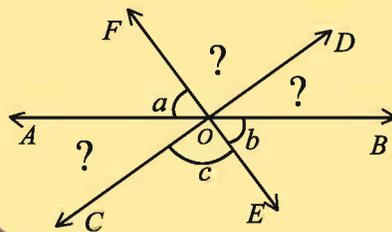
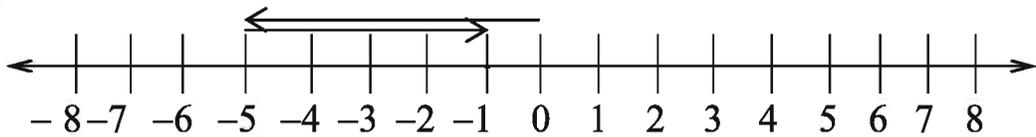

$$2x - 1 = 5$$



**Prescribed by the National Curriculum and Textbook Board
as a Textbook for class six from the academic year 2013**

Mathematics

Class Six

Written & Translated by

Saleh Motin

Dr. Amal Halder

Dr. Amulya chandra Mandal

Sheikh Kutubuddin

Hamida Banu Begum

A. K. M. Shahidullah

Md. Shahjahan Siraj

Edited by

Dr. Md. Abdul Matin

Dr. Md. Abdus Samad

Language Specialist

Alok K Saha

National Curriculum and Textbook Board, Bangladesh

Published by
National Curriculum and Textbook Board
69-70, Motijheel Commercial Area, Dhaka

[All rights reserved by the Publisher]

First Publication : December, 2012

Revised Edition : November, 2014

Reprint : July, 2018

Design

National Curriculum and Textbook Board, Bangladesh

For free distribution by the Government of the People's Republic of Bangladesh

Printed by :

Preface

The aim of secondary education is to make the learners fit for entry into higher education by flourishing their latent talents and prospects with a view to building the nation with the spirit of the Language Movement and the Liberation War. To make the learners skilled and competent citizens of the country based on the economic, social, cultural and environmental settings is also an important issue of secondary education.

The textbooks of secondary level have been written and compiled according to the revised curriculum 2012 in accordance with the aims and objectives of National Education Policy-2010. Contents and presentations of the textbooks have been selected according to the moral and humanistic values of Bengali tradition and culture and the spirit of Liberation War 1971 ensuring equal dignity for all irrespective of caste and creed of different religions and sex.

The present government is committed to ensure the successful implementation of Vision 2021. Honorable Prime Minister, Government of the People's Republic of Bangladesh, Sheikh Hasina expressed her firm determination to make the country free from illiteracy and instructed the concerned authority to give free textbooks to every student of the country. National Curriculum and Textbook Board started to distribute textbooks free of cost since 2010 according to her instruction.

Mathematics plays an important role in developing scientific knowledge and skill of the 21st century. Not only that, the application of Mathematics has increased in family and social life including personal life. Keeping all these things under consideration Mathematics has been presented easily and nicely at the Secondary Level to make it useful and delightful to the learners, and a good number of new topics have been included in the textbook.

I thank sincerely all for their intellectual labor who were involved in the process of revision, writing, editing, art and design of the textbook.

Prof. Narayan Chandra Saha

Chairman

National Curriculum and Textbook Board, Bangladesh

CONTENTS

Chapter	Title	Page No
One	Natural Numbers and Fractions	01
Two	Ratios and Percentages	45
Three	Integers	69
Four	Algebraic Expressions	88
Five	Simple Equations	110
Six	Basic Concepts of Geometry	123
Seven	Practical Geometry	143
Eight	Information and Data	158
	Answer	172

Chapter One

Natural Numbers and Fractions

At the very beginning of human civilization, human beings felt the necessity of counting to meet up their daily needs. At the very first stage they used to maintain the records of animals and objects by using various types of symbols, things or sticks of equal size and by drawing lines on floor or stones. But with the development of civilization, the need of other types of symbol was felt for counting the increased number of animals and goods. The system of counting has developed since then and this the present system of using the number has evolved.

At the end of the chapter, the students will be able to

- enumerate the natural numbers.
- read by enumerating in national and international system.
- determine Prime, Composite and Co-prime numbers.
- explain divisibility.
- verify the divisibility by 2, 3, 4, 5, 9.
- find H.C.F. and L.C.M. of common fractions and decimal fractions.
- solve Mathematical problems by simplifying the common fractions and decimal fractions.

1.1 Enumeration :

In arithmetic, all numbers can be expressed by ten symbols. These symbols are 1, 2, 3, 4, 5, 6, 7, 8, 9, 0. These are also known as digits. Again, these are numbers as well. The numbers except zero are Natural Numbers. Among them, first nine digits are significant digits and the last one is zero. The intrinsic values of the numbers are one, two, three, four, five, six, seven, eight, nine and zero respectively.

All the numbers greater than 9 are written by placing two or more than two digits side by side Any number written in digits is known as the numeration. All these ten symbols are used in enumeration. The numbers are ten based and that is why, they are called the

decimal system or the system of multiples of ten. In this system, the digit on the extreme right side expresses its intrinsic value. The second digit from the right expresses ten times of its intrinsic value.

It is to be noted that the value of any digit used in a number depends on its place in the number. The digit, used in a number, expressing the number due to its place is called the place value of that number. For example, in the number 333, the place value of the digit 3 on the extreme right is 3; the place value of 3 in the second and the third places from the right are 30 and 300 respectively. Hence, the place value of the same digit differs from place to place, but its intrinsic value remains the same.

$$\text{i.e. } 333 = 3 \times 100 + 3 \times 10 + 3$$

1.2 Local system of enumerations :

In the previous class, we have learnt how to count in national system. In this system, from the right side of a number, the first, second and the third places express ones, tens and hundreds respectively. The fourth, fifth, sixth, seventh, eighth places are called thousand, Ajut, Lac, Nijut and Crore respectively.

Crore	Lacs		Thousands		Hundreds	Tens	Ones
	Nijut	Lac	Ajut	Thousands			
Eighth	Seventh	Sixth	Fifth	Fourth	Third	Second	First

The digits in the ones' place are written or read as one, two, three, four etc. But the numbers of two digits (from 10-99) have some special names. Such as, 25, 38 and 71 are read as twenty five, thirty eight and seventy one respectively. The digits 1, 2, 3 etc. in the hundreds' place in a number are read respectively as one hundred, two hundred and three hundred etc. The digits in the thousands place are read as read in hundreds place. Such as, five thousand, seven thousand etc. The number in ajut is not read as ajut. The digits in thousands, and ajuts places are taken together and read as thousands. Such as, 7 in

ajuts and 5 in thousands places are taken together to read as seventy five thousand.

Similarly, digits in Lacs and Nijuts places are taken together and read as lacs. Such as, 8 in nijut and 3 in lac are taken together to read eighty three lac. The digit in place of crore is read as crore. The digit in the place of crore and the digits placed to the left of the place of crore are taken together and read as so many crores.

Comma (,) is used to read the numbers consisting of four or more digits easily and correctly. In this case, to read a number easily and correctly a comma (,) can be placed after three digits from the right and then after every two digits.

Example 1. Write the following number in words using comma (,)

9 8 7 5 4 7 3 2 1

Solution : If the comma (,) is placed after three digits from the right of the number and then after every two digits, we get 98, 75, 47, 321.

Now, 98 consisting of two digits are in the places of Crore, 75 consisting of two digits are in the places of Nijut and Lac, 47 consisting of two digits are in the places of Ajut and Thousand, the digit 3 is in the place of Hundred, the digit 2 is in the place of Tens and the digit 1 is in the place Ones. Hence, the number expressed in words would be: Ninety eight crores seventy five lac forty seven thousand three hundred twenty one.

Example 2. Write down in digits: seven crore five lac ninety thousand and seven

Solution :	Crore	Nijut	Lac	Ajut	Thousands	Hundreds	Tens	Ones
	7	0	5	9	0	0	0	7

It is noticed after enumeration of the number that there are no digits in the places of Nijut, Hundreds and Tens. By placing zeros in the blanks, the number is obtained.

∴ The number is 7, 05, 90, 007.

Example 3. Write down the greatest and the smallest numbers consisting of seven digits.

Solution : We know that 9 is the greatest number consisting of one digit. The place value of 9 in any place in the enumeration of any number will be the greatest.

Hence, the greatest number consisting of seven digits will be obtained by writing the digit 9 seven times successively.

Therefore, the required greatest number is 99, 99, 999. Again, least number is 0 (Zero). The number remains 0 by writings seven zeros successively. Hence, The smallest number will be obtained by writing smallest significant digit 1 (one) in the extreme left and then putting successively six 0s.

Therefore, the required least number is 10, 00, 000.

Example 4. Form the greatest and the least numbers consisting of six digits 8, 0, 7, 5, 3, 4 using each of the digits once only.

Solution : The place value of greater digit is greater than that of smaller digit in the same position in enumeration.

Here, $8 > 7 > 5 > 4 > 3 > 0$

Hence, the greatest number consisting of six digits will be formed if the digits are placed in the descending order in-enumeration.

Therefore, the required greatest number is 8, 75, 430.

Again, $0 < 3 < 4 < 5 < 7 < 8$

Hence, the smallest number will be formed if the digits are placed in ascending order in enumeration. But if 0 (zero) is placed in the extreme left, it will not be a significant number consisting of six digits. It will be a number of five digits. Therefore, the smallest number is obtained by placing the smallest digit, except zero, in the extreme left and by writing the digits including zero in ascending orders in enumeration.

Therefore, the required least number is 3,04,578.

1.3 International counting system

In this system, the places from ones to billions are arranged successively as follows :

Billions	Millions	Thousands	Hundreds	Tens	Ones
111	111	111	1	1	1

The digits in the places of Ones, Tens and Hundreds are read and expressed in words as our local system. The place just to the left of the hundreds is the place of thousands. A number consisting of not more than three digits can be written in the places of thousands and the written number is read as so many thousand. Such as, the written number in thousands in the above table is one hundred eleven and the number is read as one hundred eleven thousand . The place to the left of the thousands is the place of millions and a number consisting of not more than three digits can be written in the place of millions. The written number is read as so many million. Such as, the written number in the place of million in the table is one hundred eleven and it is to be read as one hundred eleven million . The place to the left of million is billion. The number written is read as so many billion. Such as, the number written in the table is one hundred eleven and read as one hundred eleven billion.

A comma (,) is placed after every three digits starting from the right to facilitate the reading of the numbers, which is the international system of counting.

1.4 Relationship between Local and International Systems

		Creore	Nijut	Lac	Ajut	Thousands	Hundreds	Tens	Ones
Billions	Millions		Thousands			Hundreds	Tens	Ones	
111	111		111			1	1	1	

Observe : * The place value of the digit 1 to the extreme right in the place of millions is 1 million. This is the position of

Nijut in the national system and its place value is 1 nijut or 10 lac.

- * The place value of the digit 1 to the extreme right in the place of billions is 1 billion. But the place value of this digit 1 in the Local System is 100 crore.

Hence, we get

$\begin{aligned} 1 \text{ Million} &= 10 \text{ lac} \\ 1 \text{ Billion} &= 100 \text{ crore} \end{aligned}$

Example 5. Express the number 204340432004 in words in the International System.

Solution : By placing comma (,) after every three digits starting from the right, we get 204,340,432,004. Hence, the number expressed in words is two hundred four billion three hundred forty million four hundred thirty two thousand and four.

- Example 6.**
- (a) How many lacs make 5 millions ?
 - (b) How many billions make 500 crore ?

Solution :

- (a) $1 \text{ million} = 10 \text{ lac}$
 $\therefore 5 \text{ millions} = (5 \times 10) \text{ lac} = 50 \text{ lac}$
- (b) $100 \text{ crore} = 1 \text{ million}$
 $\therefore 1 \text{ core} = (1 \div 100) \text{ million}$
 $\therefore 500 \text{ billion} = (500 \div 100) \text{ billion} = 5 \text{ billion}$

Exercise 1.1

1. Write down the following numbers in digits :

- (a) Twenty thousand seventy ; thirty thousand eight; fifty five thousand four hundred.
- (b) Four lac five thousand ; seven lac two thousand seventy five.
- (c) Seventy six lac nine thousand seventy ;Thirty lac nine hundred four.

- (d) Five crore three lac two thousand seven.
- (e) Ninety eight crore seven lac five thousand nine.
- (f) One hundred two crore five thousand seven hundred eight.
- (g) Nine hundred fifty five crore seven lac ninety.
- (h) Three thousand five hundred crore eighty five lac nine hundred twenty one.
- (i) Fifty billion three hundred one million five hundred thirty eight thousand.

2. Read the following numbers and write down them in words :

- (a) 45789 ; 41007 ; 891071.
- (b) 200078 ; 790678 ; 890075.
- (c) 4400785 ; 6870509 ; 7105070.
- (d) 50877003 ; 94309799 ; 83900765.

3. Determine the place value of the significant digits in the following numbers :

- (a) 72 (b) 359 (c) 4203 (d) 70809 (e) 130045078 (f) 250009709
- (g) 5900007845 (h) 900758432 (i) 105780923004.

4. Write down the greatest and the smallest numbers consisting of nine digits.

5. Form the greatest and the smallest numbers consisting of seven digits using the digits only once:

- (a) 4, 5, 1, 2, 8, 9, 3 (b) 4, 0, 5, 3, 9, 8, 7.

6. Which are the greatest and the smallest numbers consisting of seven digits having 7 in the first and 6 in the last position of the numbers ?

7. Express in words the number obtained by arranging the digits of the number 73455 conversely.

1.5 Prime Number and Composite Number

The factors of some numbers are written below :

Numbers	Factors
2	1, 2
5	1, 5
13	1, 13

Observe: The factors of each of the numbers 2, 5 and 13 in the above table are only 1 and the number itself. Such numbers are called **Prime Numbers**.

Numbers	Factors
6	1, 2, 3, 6
9	1, 3, 9
12	1, 2, 3, 4, 6, 12

Again, the factors of 6, 9 and 12 are 1 and there are numbers more than one other than that. Such numbers are called **Composite Numbers**.

1.6 Co-Prime Numbers

8 and 15 are two natural numbers.

Here, $8 = 1 \times 2 \times 2 \times 2$ and $15 = 1 \times 3 \times 5$

Observe : The factors of 8 are 1, 2, 4, 8 and the factors of 15 are 1, 3, 5, 15. We can see that there is no common factors except 1 of the numbers 8 and 15. That is why numbers 8 and 15 are Co-Prime numbers to each other.

Again, there is no common factors except 1 of the numbers 10, 21 and 143. So, the numbers are co-prime to each other.

If the common factor of two or more numbers is only 1, then the numbers are Co-Prime to each other.

Activity :

1. Write ten prime numbers of 2 digits
2. Determine the prime numbers from 101 to 150.
3. Determine co-prime numbers of the following pairs :
(a) 16, 28 (b) 27, 38 (c) 31, 43 (d) 210, 143

1.7 Divisibility**Divisible by 2**

Writing some multiples of 2 we get

$$2 \times 0 = 0, 2 \times 1 = 2, 2 \times 2 = 4, 2 \times 3 = 6, 2 \times 4 = 8, \\ 2 \times 5 = 10, 2 \times 6 = 12, 2 \times 7 = 14, 2 \times 8 = 16, 2 \times 9 = 18 \text{ etc.}$$

Let us observe the process of the product. Any number when multiplied by 2, the ones place of the product will be 0, 2, 4, 6 or 8. Therefore, the numbers having 0, 2, 4, 6 or 8 in ones place will be divisible by 2. Such numbers are called Even Number.

If the digit of the ones place of a number is 0 (zero) or an Even Number, the number is divisible by 2.

Divisible by 4

If the number 3512 is written in terms of place value, we get,

$$3512 = 3000 + 500 + 10 + 2$$

Here, 10 is not divisible by 4 but the digits on the left of tens place is divisible by 4.

$$\text{Again, } 3512 = 3000 + 500 + 12$$

Here, 12 is divisible by 4. Therefore, 3512 is divisible by 4, i.e since the number formed by the digits of ones and tens is divisible by 4, the given number will be divisible by 4.

If any number formed by the digits of ones and tens place of a number is divisible by 4, the given number will be divisible by 4. Again, if the number of both tens and ones place is 0, the number will also be divisible by 4.

Divisible by 5

Let us write some multiples of 5 :

$$5 \times 0 = 0, \quad 5 \times 1 = 5, \quad 5 \times 2 = 10, \quad 5 \times 3 = 15, \quad 5 \times 4 = 20, \\ 5 \times 5 = 25, \quad 5 \times 6 = 30, \quad 5 \times 7 = 35, \quad 5 \times 8 = 40, \quad 5 \times 9 = 45 \text{ etc.}$$

If we observe the process of products, we see that each of the product has 0 or 5 in its ones place. Therefore, if any number has 0 or 5 in its ones place, that number will be divisible by 5.

If any number has 0 or 5 in its ones place, the number will be divisible by 5.

Divisible by 3

1 4 7

_____ place value of 7 = 7
 _____ place value of 4 = 40 = 36 + 4 = (3 × 3 × 4) + 4
 _____ place value of 1 = 100 = 99 + 1 = (3 × 3 × 11) + 1

Here, numbers $3 \times 3 \times 4$ and $3 \times 3 \times 11$ are divisible by 3 and the sum of the digits in ones, tens and hundreds place is $= 1 + 4 + 7 = 12$ which is divisible by 3.

∴ The number 147 is divisible by 3.

Again, let us consider a number 148:

1 4 8

_____ place value of 8 = 8
 _____ place value of 4 = 40 = 36 + 4 = (3 × 3 × 4) + 4
 _____ place value of 1 = 100 = 99 + 1 = (3 × 3 × 11) + 1

Here, numbers $3 \times 3 \times 4$ and $3 \times 3 \times 11$ are divisible by 3 but the sum of digits in ones, tens and hundreds place is $= 1 + 4 + 8 = 13$ which is not divisible by 3.

∴ The number 148 is not divisible by 3.

If the sum of the digits of a number is divisible by 3, the number is also divisible by 3.

Divisible by 6

Any number divisible by 2 and 3 will also be divisible by 6.

Divisible by 9

Let us consider a number 378.

3 7 8

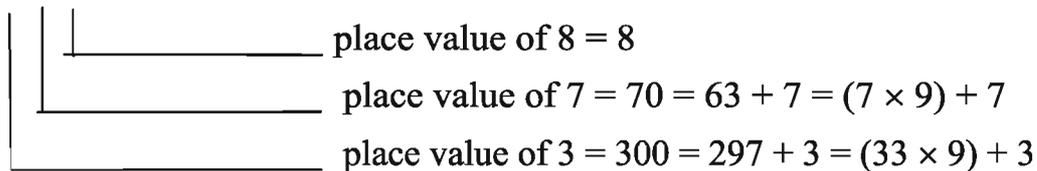

Here, each of the numbers 7×9 and 33×9 is divisible by 9 and the summation of digits in ones, tens and hundreds place is $3 + 7 + 8 = 18$ which is divisible by 9. So, 378 is divisible by 9.

If the sum of the digits of any number is divisible by 9, the given number will also be divisible by 9.

Activity :

Write numbers consisting of 3 or 4 or 5 digits which are divisible by 3 and 9.

Example 1: When Zarif asked Jawad to write six numbers consisting of one digit, he wrote 2, 0, 3, 8, 7 and 4. Writing $475 \square 2$, Zarif told Jawad there are some digits which, if put in the blank place, make numbers which are divisible by 3 each time.

- Separate prime numbers from the numbers written by Jawad and explain why they are prime numbers.
- Show that the subtraction of the greatest and the smallest number formed by the numbers written by Jawad is divisible by 9.
- Determine which number will be put in the blank \square .

Solution:

(a) The digits written by Jawad are : 2, 0, 3, 8, 7 and 4. Of these digits the prime numbers are 2, 3, 7

Because, $2=1 \times 2$, $3=1 \times 3$, $7=1 \times 7$

Therefore, the factor of 2, 3, 7 is 1 and the number itself.

(b) The digits written by Jawad are : 2, 0, 3, 8, 7 and 4.

Here, $8 > 7 > 4 > 3 > 2 > 0$

Therefore, the greatest number formed by 2, 0, 3, 8, 7 and 4 is 874320 and the smallest number = 203478.

Now, the subtraction of the greatest number and the smallest number formed = $874320 - 203478 = 670842$

Again, the sum of the digits of the number 670842 = $6 + 7 + 0 + 8 + 4 + 2 = 27$, which is divisible by 9.

So, the subtraction of the greatest and the smallest number formed is divisible by 9 (shown).

(c) The sum of the digits used in $475 \square 2$ is $4 + 7 + 5 + 2 = 18$; which is divisible by 3. So, if 0 is placed in \square the number will be divisible by 3.

If 3 is added to the sum of the digits, it becomes $18 + 3 = 21$ which is divisible by 3. Therefore, if 3 is put in the number it formed it will be divisible by 3. Similarly, $18 + 6 = 24$ which is divisible by 3.

So, if either of 6 or 9 is placed in \square , the number formed will also be divisible by 3. Therefore, if any of the digits 0, 3, 6, 9 is put in \square , the number formed will be divisible by 3 in each case.

Exercise 1.2

- Write down the prime numbers between 30 to 70 :
- Determine which of the following pairs are co-prime :
(a) 27, 54 (b) 63, 91 (c) 189, 210 (d) 52, 97
- Which of the following numbers are divisible by the numbers as indicated?
(a) 545, 6774, 8535 by 3 (b) 8542, 2184, 5274 by 4
(c) 2184, 1074, 7832 by 6 (d) 5075, 1737, 2193 by 9
- Which digits are to be put in the blanks so that each of the following numbers is divisible by 9 ?
(a) $5 \square 4723$ (b) $812 \square 74$ (c) $\square 41578$ (d) $5742 \square$
- Determine the smallest number of 5 digits which is divisible by 3.
- Determine the greatest number of 7 digits which is divisible by 6.

7. Determine whether the greatest and the smallest numbers formed by the digits 3, 0, 5, 2, 7 are divisible by 4 and 5.

1.8 Highest Common Factor (H.C.F.)

We know that factors of 12 are 1, 2, 3, 4, 6 and 12

and factors of 30 are 1, 2, 3, 5, 6, 10, 15 and 30

Here, common factors of 12 and 30 are 1, 2, 3 and 6

Among those common factors, the highest common factor is 6.

\therefore H.C.F. of 12 and 30 is 6.

The greatest of the factors among the common factors of the given numbers is called the Highest Common Factor of those given numbers. It is shortly written as H.C.F.

Again, we know, prime factors of 12 are 2, 2, 3 and prime factors of 30 are 2, 3, 5

\therefore Common prime factors of 12 and 30 are 2, 3

\therefore H.C.F. of 12 and 30 = $2 \times 3 = 6$

The product of the common prime factors of the given numbers is the H.C.F. of the given numbers.

Example 1. Determine H.C.F. of 28, 48 and 72 by the help of factors and both prime factors.

Solution : Determination of H.C.F. by the help of factors :

Here, factors of 28 are 1, 2, 4, 7, 14, 28

factors of 48 are 1, 2, 3, 4, 6, 8, 12, 16, 24, 48

and factors of 72 are 1, 2, 3, 4, 6, 8, 9, 12, 18, 24, 36, 72

\therefore Among common factors of 28, 48 and 72, the highest common factor is 4.

\therefore H.C.F. of 28, 48 and 72 is 4.

Determination of H.C.F. by prime factors :

Here, prime factors of 28 are 2, 2, 7

prime factors of 48 are 2, 2, 2, 2, 3

and prime factors of 72 are 2, 2, 2, 3, 3

\therefore Common prime factors of 28, 48 and 72 are 2, 2

\therefore H.C.F. of 28, 48 and 72 = $2 \times 2 = 4$.

Determination of H.C.F. by division method :**Example 2.** Determine the H.C.F. of 12 and 30.**Solution :** Here, $12 \overline{) 30} (2$

$$\begin{array}{r} \underline{24} \\ 6 \overline{) 12} (2 \\ \underline{12} \\ 0 \end{array}$$

The last divisor is 6.

 \therefore H.C.F. of 12 and 30 is 6.**Example 3.** Determine H.C.F. of 28, 48 and 72.**Solution :** $28 \overline{) 48} (1$

$$\begin{array}{r} \underline{28} \\ 20 \overline{) 28} (1 \\ \underline{20} \\ 8 \overline{) 20} (2 \\ \underline{16} \\ 4 \overline{) 8} (2 \\ \underline{8} \\ 0 \end{array}$$

Again, $4 \overline{) 72} (18$

$$\begin{array}{r} \underline{4} \\ 32 \\ \underline{32} \\ 0 \end{array}$$

Here, the last divisor is 4 which is H.C.F. of 28 and 48 and 72 is divisible by 4 .

 \therefore H.C.F. of 28, 48 and 72 is 4.**Activity:**

Write the smallest number consisting of 4 digits and the greatest number consisting of 3 digits in each of which 8 will be in ones place. Find the H.C.F. of these two numbers by prime factors and division process.

1.9 Lowest Common Multiple (L.C.M.)

We know, multiples of 4 are : 4, 8, 12, 16, 20, $\boxed{24}$, 28, 32, 36, 40, 44, $\boxed{48}$ etc.
 multiples of 6 are : 6, 12, 18, $\boxed{24}$, 30, 36, 42, $\boxed{48}$, 54 etc.
 and multiples of 8 are : 8, 16, $\boxed{24}$, 32, 40, $\boxed{48}$, 56, 64 etc,

We can see, common multiples of 4, 6 & 8 are 24, 48 etc. and among them the lowest multiple is 24.

\therefore L.C.M. of 4, 6 and 8 is 24.

The lowest common multiple of two or more numbers is called their Lowest Common Multiple (L.C.M.).

Again, if we write the prime factors of 4, 6, 8, we get

$$4 = 2 \times 2, \quad 6 = 2 \times 3, \quad 8 = 2 \times 2 \times 2$$

In prime factors of 4, 6, 8 the maximum repetition of 2 is 3 times and that of 3 is 1 time. So, successive multiplication of 3 times of 2 and 1 time of 3 gives $2 \times 2 \times 2 \times 3$ or 24 which is L.C.M. of the given numbers.

Determination of L.C.M. by Euclid's Process :

Example 4. Determine L.C.M. of 12, 18, 20, 105.

Solution :

$$\begin{array}{r|l}
 2 & 12, 18, 20, 105 \\
 \hline
 2 & 6, 9, 10, 105 \\
 \hline
 3 & 3, 9, 5, 105 \\
 \hline
 5 & 1, 3, 5, 35 \\
 \hline
 & 1, 3, 1, 7
 \end{array}$$

$$\therefore \text{Required L.C.M.} = 2 \times 2 \times 3 \times 5 \times 3 \times 7 = 1260$$

It is to be noted from the above example:

- The numbers are written in a row placing comma (,) in between them and a line \perp is drawn under them.
- At least two of the given numbers are divided by a prime number. The quotients of the numbers divisible by the factor are written below the line along with indivisible numbers remaining unchanged.
- Similar activity has been done with the number of the next row.
- The process continues until the numbers in the last row are co-prime numbers.

- The required L.C.M. is the successive multiplication of the divisors and the numbers of the last row.

1.10 Relationship between L.C.M. and H.C.F.

Prime factors of any two numbers 10 and 30 are determined below :

$$10 = 2 \times 5$$

$$30 = 2 \times 3 \times 5$$

$$\therefore \text{H.C.F. of 10 and 30} = 2 \times 5 = 10 \text{ and L.C.M.} = 2 \times 3 \times 5 = 30$$

$$\begin{aligned} \text{Again, product of 10 and 30} &= 10 \times 30 = (2 \times 5) \times (2 \times 3 \times 5) \\ &= \text{H.C.F.} \times \text{L.C.M.} \end{aligned}$$

\therefore Product of two numbers is equal to the product of L.C.M. and H.C.F. of those numbers.

Product of two numbers = H.C.F. of two numbers \times L.C.M. of two numbers.

Activity :

Determine the H.C.F. and L.C.M. of two or three numbers consisting of two digits and perform a quick quiz contest among one of another.

Example 5. Determine L.C.M. of 30, 36 and 40 with the help of prime factors.

Solution : Here, $30 = 2 \times 3 \times 5$

\therefore prime factors of 30 are 2, 3, 5

$$36 = 2 \times 2 \times 3 \times 3$$

\therefore prime factors of 36 are 2, 2, 3, 3

$$\text{and } 40 = 2 \times 2 \times 2 \times 5$$

\therefore prime factors of 40 are 2, 2, 2, 5

$$\therefore \text{L.C.M. of 30, 36, 40} = 2 \times 2 \times 2 \times 3 \times 3 \times 5 = 360$$

\therefore Required L.C.M. is 360

Example 6. Determine the H.C.F. of 42, 48 and 56 by division method :

Solution : Here, $42 \overline{) 56} (1$

Again, $14 \overline{) 48} (3$

$$\begin{array}{r} \underline{42} \\ 14 \overline{) 42} (3 \\ \underline{42} \\ 0 \end{array}$$

$$\begin{array}{r} \underline{42} \\ 6 \overline{) 14} (2 \\ \underline{12} \\ 2 \overline{) 6} (3 \\ \underline{6} \\ 0 \end{array}$$

\therefore Last divisor is 2

\therefore Required H.C.F. is 2

Example 7. What is the greatest number which divides 365 and 463 with the remainders 5 and 7 respectively ?

Solution: With the remainders 5 and 7 respectively, when 365 and 463 are divided by the greatest number, the greatest number will be the H.C.F. of $(365 - 5)$ or 360 and $(463 - 7)$ or 456.

Here, $360 \) \ 456 \ (\ 1$

$$\begin{array}{r}
 \underline{360} \\
 96)360(3 \\
 \underline{288} \\
 72)96(1 \\
 \underline{72} \\
 24)72(3 \\
 \underline{72} \\
 0
 \end{array}$$

\therefore H.C.F of 360 and 456 is 24.

\therefore Required greatest number is 24.

Example 8. What is the greatest number which divides 57, 98 and 183 with no remainder ?

Solution : Required greatest number will be the H.C.F. of 57, 98 and 183.

Here, $57 = 3 \times 19$, $93 = 3 \times 31$ and $183 = 3 \times 61$

\therefore H.C.F. of 57, 93 and 183 is 3.

\therefore Required greatest number is 3.

Example 9. What is the smallest number when added by 5 the summation will be divided by 16, 24 and 32 ?

Solution : The required number will be 5 less than L.C.M. of 16, 24 and 32.

$$\begin{array}{r}
 2 \ | \ 16, 24, 32 \\
 \hline
 2 \ | \ 8, 12, 16 \\
 \hline
 2 \ | \ 4, 6, 8 \\
 \hline
 2 \ | \ 2, 3, 4 \\
 \hline
 1, 3, 2
 \end{array}$$

\therefore L.C.M. of 16, 24 and 32 = $2 \times 2 \times 2 \times 2 \times 3 \times 2 = 96$

\therefore Required least number will be $(96 - 5)$ or 91.

Example 10 :

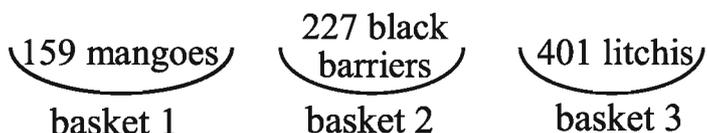

- a) Determine the factors of 159 and then separate the prime factors.
- b) If 9 mangoes, 7 black berries and 1 litchi get rotten, find out the L.C.M. of the remaining fruits by Euclid's method.
- c) What is the highest number of boys among whom the fruits can be equally distributed with 3 mangoes, 6 black berries and 11 litchis left?

Solution

(a) $159 = 1 \times 159$
 $= 3 \times 53$

the factors of 159 are 1, 3, 53 and 159. Of them 3 and 53 are prime factors.

- (b) The number of good mangoes in basket 1 is $159 - 9 = 150$
 The number of good mangoes in baskets 2 is $227 - 7 = 220$.
 The number of good mangoes in basket 3 is $401 - 1 = 400$.

Now,

$$\begin{array}{r}
 2 \overline{) 150, 220, 400} \\
 \underline{2 \overline{) 75, 110, 200}} \\
 \quad 5 \overline{) 75, 55, 100} \\
 \quad \quad 5 \overline{) 15, 11, 20} \\
 \quad \quad \quad 3, 11, 4
 \end{array}$$

\therefore The L.C.M. of 150, 220 and 400 is $2 \times 2 \times 5 \times 5 \times 3 \times 4 \times 11 = 13200$

- (c) Here, $159 - 3 = 156$

$$227 - 6 = 221$$

$$401 - 11 = 390$$

The required number of boys will be the H.C.F. of 156, 221 and 390.

Here,

$$\begin{array}{r}
 156)221(1 \\
 \underline{156} \\
 65)156(2 \\
 \underline{130} \\
 26)65(2 \\
 \underline{52} \\
 13)26(2 \\
 \underline{26} \\
 0
 \end{array}$$

Again,

$$\begin{array}{r}
 13)390(30 \\
 \underline{39} \\
 0 \\
 \underline{0} \\
 0
 \end{array}$$

So, the L.C.M of 156, 221 and 390 is 13.

So, the number of boys is 13

Alternative Method

$$\begin{array}{r}
 2|156 \\
 2|78 \\
 3|39 \\
 13
 \end{array}$$

So, $156 = 2 \times 2 \times 3 \times 3 \times 13$

$$\begin{array}{r}
 13|221 \\
 17
 \end{array}$$

So, $221 = 13 \times 17$

$$\begin{array}{r}
 2|390 \\
 3|195 \\
 5|65 \\
 13
 \end{array}$$

So, $390 = 2 \times 3 \times 5 \times 13$

So, the prime factor of 156, 221 and 390 is 13

So, the number of boys is 13.

Exercise 1.3

1. Determine H.C.F. using prime factors :
 - (a) 144, 240, 612
 - (b) 525, 495, 570
 - (c) 2666, 9699
2. Determine H.C.F. by division method :
 - (a) 105, 165
 - (b) 385, 286, 418
3. Determine L.C.M. using prime factors :
 - (a) 15, 25, 30
 - (b) 22, 88, 132, 198
 - (c) 24, 36, 54, 72, 96
4. Determine L.C.M. by Euclid's method : :
 - (a) 96, 120
 - (b) 35, 49, 91
 - (c) 33, 55, 60, 80, 90

5. What is the greatest number which divides 100 and 184 with the remainder 4 in every time ?
6. What is the greatest number which divides 27, 40 and 65 with remainders 3, 4, 5 respectively?
7. Which smallest number will have 5 as remainder in every case when divided by 8, 12, 18 and 24?
8. Which smallest number will have 15, 20, 25, 31 and 43 as remainder respectively when divided by 20, 25, 30, 36 and 48 ?
9. The length of a iron-sheet and a copper-sheet is 672 cm and 960 cm respectively. What will be the length of the highest piece of equal size cut from the two sheets ? Determine the number of pieces of sheets ?
10. What is the least number of 4 digits which is divided by 12, 15, 20 and 35 ?
11. What is the greatest number of 5 digits which will be divided by 16, 24, 30 and 36, with 10 as remainder in each case ?
12. Four buses traverse a distance of 10 km, 20 km, 24 km. and 32 km respectively from a bus-stand after a definite interval of time. What is the minimum distance traversed by the buses when they meet together ?
13. The product of two numbers is 3380 and their H.C.F. is 13. Determine the L.C.M. of the two numbers.

Fractions

1.11 Common Fractions

In previous class, we have learnt about fractions. Here, we shall discuss on common fractions. Common fractions are of three types. They are : Proper fractions, Improper fractions and Mixed fractions.

Proper fraction : $\frac{3}{5}$ is a common fraction. In this fraction numerator is 3 and denominator is 5. Here the numerator is less than the denominator. So, it is a proper fraction.

Improper fraction : In the fraction $\frac{8}{5}$, the numerator is greater than the denominator. It is an improper fraction.

Mixed fraction : In the fraction $1\frac{2}{3}$, there is an integral part and an another part which is a proper fraction. $1\frac{2}{3}$ is a mixed fraction.

Equivalent fractions : $\frac{5}{7}$ and $\frac{15}{21}$ are two fractions.

Here, the numerator of the first fraction \times the denominator of the second fraction = $5 \times 21 = 105$

The denominator of the first the fraction \times the numerator of the second fraction = $7 \times 15 = 105$

\therefore The two fractions are equivalent :

Again, $\frac{15}{21} = \frac{5 \times 3}{7 \times 3} = \frac{\text{The Numerator of the first fraction} \times 3}{\text{The Denominator of the first fraction} \times 3}$

and $\frac{5}{7} = \frac{15 \div 3}{21 \div 3} = \frac{\text{The Numerator of the second fraction} \div 3}{\text{The Denominator of the second fraction} \div 3}$

If we multiply or divide the numerator and the denominator of a fraction by the same number, except by 0 (zero), we get a fraction which is equivalent to the given fraction.

Example 1. Express $2\frac{2}{5}$ into a common fraction.

Solution : $2\frac{2}{5}$
 i.e., $2\frac{2}{5} = \frac{2 \times 5 + 2}{5}$

Explanation :

$$2\frac{2}{5} = 2 + \frac{2}{5} = \frac{2}{1} + \frac{2}{5} = \frac{2 \times 5}{1 \times 5} + \frac{2}{5} = \frac{2 \times 5 + 2}{5}$$

$$= \frac{12}{5} \qquad = \frac{2 \times 5 + 2}{5} = \frac{12}{5}$$

Formula for Expressing a mixed fraction into a common fraction :

$$\text{Mixed fraction} = \frac{\text{Integer} \times \text{Denominator} + \text{Numerator}}{\text{Denominator}}$$

1.12 Comparison of fractions

$\frac{5}{7}$ and $\frac{3}{4}$ are two common fractions.

Here, the product of the numerator of the first fraction and the denominator of the second fraction = $5 \times 4 = 20$

Again, the product of the numerator of the second fraction and the denominator of the first fraction. = $3 \times 7 = 21$

As $20 < 21$, so, $\frac{5}{7} < \frac{3}{4}$ or $\frac{3}{4} > \frac{5}{7}$

Again, L.C.M. of the denominators 7 and 4 of the fractions = $7 \times 4 = 28$

\therefore The first fraction $\frac{5}{7} = \frac{5 \times 4}{7 \times 4} = \frac{20}{28}$ [as $28 \div 7 = 4$]

And the second fraction $\frac{3}{4} = \frac{3 \times 7}{4 \times 7} = \frac{21}{28}$ [as $28 \div 4 = 7$]

The denominators of the fractions $\frac{20}{28}$ and $\frac{21}{28}$ are same i.e., they are with equal denominators. But, the numerator 20 of the first fraction is less than the numerator 21 of the second fraction.

$\therefore \frac{20}{28} < \frac{21}{28}$ or, $\frac{5}{7} < \frac{3}{4}$ or $\frac{3}{4} > \frac{5}{7}$

If the denominators of two fractions are equal, the fraction having a greater numerator is greater than the other.

Again, the numerators of the fractions $\frac{5}{7}$ and $\frac{3}{4}$ are 5 and 3 respectively and the L.C.M. of 5 and 3 = $5 \times 3 = 15$

$$\text{1st fraction } \frac{5}{7} = \frac{5 \times 3}{7 \times 3} = \frac{15}{21} \quad [\text{ as } 15 \div 5 = 3]$$

$$\text{2nd fraction } \frac{3}{4} = \frac{3 \times 5}{4 \times 5} = \frac{15}{20} \quad [\text{ as } 15 \div 3 = 5]$$

Here, the numerators of $\frac{15}{21}$ and $\frac{15}{20}$ are equal i.e. with the same numerator.

Here, $\frac{15}{21} < \frac{15}{20}$, as $15 \times 20 < 15 \times 21$

If the numerators of two fractions are equal, the fraction having a greater denominator is less than the other.

Example 2. Arrange the fractions $\frac{1}{8}$, $\frac{3}{16}$ and $\frac{7}{24}$ in ascending order of their values.

Solution: The L.C.M. of the denominators 8, 16 and 24 of the given fractions = 48

$$\text{The 1st fraction} = \frac{1}{8} = \frac{1 \times 6}{8 \times 6} = \frac{6}{48} \quad [\text{ as } 48 \div 8 = 6]$$

$$\text{The 2nd fraction} = \frac{3}{16} = \frac{3 \times 3}{16 \times 3} = \frac{9}{48} \quad [\text{ as } 48 \div 16 = 3]$$

$$\text{and the 3rd fraction} = \frac{7}{24} = \frac{7 \times 2}{24 \times 2} = \frac{14}{48} \quad [\text{ as } 48 \div 24 = 2]$$

If we compare the numerators of the fractions $\frac{6}{48}$, $\frac{9}{48}$, $\frac{14}{48}$ having an equal denominator

$$\text{we get, } 6 < 9 < 14, \therefore \frac{6}{48} < \frac{9}{48} < \frac{14}{48} \text{ i.e. } \frac{1}{8} < \frac{3}{16} < \frac{7}{24}$$

\therefore Arranging the given fractions in the ascending order we get, $\frac{1}{8} < \frac{3}{16} < \frac{7}{24}$

Activity : 1. Arrange the fractions $\frac{5}{8}$, $\frac{7}{12}$, $\frac{11}{16}$ and $\frac{1}{24}$ in the descending order of values

1.13 Addition and Subtraction of fractions

Adding the fractions $\frac{7}{13}$ and $\frac{2}{13}$ we get,

$$\frac{7}{13} + \frac{2}{13} = \frac{7+2}{13} = \frac{9}{13}$$

The sum of the fractions having the same denominator is a fraction whose denominator is the denominator of the given fractions and the numerator is the sum of the numerators of the given fractions.

Again, subtracting $\frac{2}{13}$ from $\frac{7}{13}$ we get,

$$\frac{7}{13} - \frac{2}{13} = \frac{7-2}{13} = \frac{5}{13}$$

The difference of the fractions having the same denominator is a fraction whose denominator is the denominator of the given fractions and the numerator is the difference of the numerators of the given fractions.

Example 3. $\frac{1}{8} + \frac{3}{16} + \frac{7}{24} = ?$

Solution : The L.C.M. of the denominators 8, 16 and 24 of the fractions is 48

$$\text{Now, } \frac{1}{8} = \frac{1 \times 6}{8 \times 6} = \frac{6}{48}$$

$$\frac{3}{16} = \frac{3 \times 3}{16 \times 3} = \frac{9}{48}$$

$$\text{and, } \frac{7}{24} = \frac{7 \times 2}{24 \times 2} = \frac{14}{48}$$

$$\therefore \frac{1}{8} + \frac{3}{16} + \frac{7}{24} = \frac{6}{48} + \frac{9}{48} + \frac{14}{48} = \frac{6+9+14}{48} = \frac{29}{48}$$

$$\text{Required sum} = \frac{29}{48}$$

The sum of fraction by short method :

The L.C.M. of the denominators 8, 16, 24 of the fractions = 48

$$\therefore \frac{1}{8} + \frac{3}{16} + \frac{7}{24} = \frac{1 \times 6 + 3 \times 3 + 7 \times 2}{48} = \frac{6 + 9 + 14}{48} = \frac{29}{48}$$

$$\text{Required sum} = \frac{29}{48}$$

Example 4. $2\frac{3}{13} + 1\frac{5}{26} = ?$

Solution : $2\frac{3}{13} + 1\frac{5}{26} = 2 + \frac{3}{13} + 1 + \frac{5}{26} = (2+1) + \left(\frac{3}{13} + \frac{5}{26}\right)$
 $= 3 + \frac{3 \times 2 + 5 \times 1}{26} = 3 + \frac{6+5}{26} = 3 + \frac{11}{26} = 3\frac{11}{26}$

Required sum = $3\frac{11}{26}$

The sum of fraction by alternative method :

$$2\frac{3}{13} + 1\frac{5}{26} = \frac{2 \times 13 + 3}{13} + \frac{1 \times 26 + 5}{26} \quad [\text{Expressing as improper fractions}]$$

$$= \frac{29}{13} + \frac{31}{26} = \frac{29 \times 2 + 31 \times 1}{26} = \frac{58 + 31}{26}$$

$$= \frac{89}{26} = 3\frac{11}{26}$$

Required sum = $3\frac{11}{26}$

Example 5. Simplify : $2 + 1\frac{2}{3} - \frac{3}{4}$

Solution : $2 + 1\frac{2}{3} - \frac{3}{4} = 2 + \frac{5}{3} - \frac{3}{4}$
 $= \frac{24 + 20 - 9}{12} = \frac{44 - 9}{12} = \frac{35}{12} = 2\frac{11}{12}$

Required value : $2\frac{11}{12}$

Activity :

1. Simplify : $2\frac{1}{2} + 3\frac{1}{3} - 4\frac{1}{4}$

2. What must be added to the sum of the fractions $10\frac{5}{14}$ and $38\frac{11}{21}$ in order to make the sum 100 ?

Example 6. Add : 20 metre $1\frac{3}{5}$ cm + 7 metre $2\frac{3}{10}$ cm

Solution : 20 metre $1\frac{3}{5}$ cm + 7 metre $2\frac{3}{10}$ cm

$$= 20 \text{ metre} + 7 \text{ metre} + 1\frac{3}{5} \text{ cm} + 2\frac{3}{10} \text{ cm}$$

$$= (20+7) \text{ metre} + \left(\frac{8}{5} + \frac{23}{10}\right) \text{ cm}$$

$$= 27 \text{ metre} + \frac{16+23}{10} \text{ cm} = 27 \text{ metre} + \frac{39}{10} \text{ cm}$$

$$= 27 \text{ metre} 3\frac{9}{10} \text{ cm}$$

Required sum = 27 metre $3\frac{9}{10}$ cm

Example 7. A man walked $2\frac{1}{4}$ km . path on foot, $3\frac{5}{8}$ km by rickshaw and $8\frac{3}{20}$ km by bus. What is the total path traversed by the man ?

Solution : The total distance traversed by the man

$$= 2\frac{1}{4} \text{ km} + 3\frac{5}{8} \text{ km} + 8\frac{3}{20} \text{ km}$$

$$= \left(\frac{9}{4} + \frac{29}{8} + \frac{163}{20}\right) \text{ km} = \frac{90+145+326}{40} \text{ km}$$

$$= \frac{561}{40} \text{ km} = 14\frac{1}{40} \text{ km}$$

Required traversed distance is $14\frac{1}{40}$ km

Exercise 1.4

1. Determine whether each of the following pairs of fractions are equivalent or not :

(a) $\frac{5}{8}, \frac{15}{24}$ (b) $\frac{7}{11}, \frac{14}{33}$ (c) $\frac{38}{50}, \frac{114}{150}$

2. Express the fractions below as fractions having equal denominators :

(a) $\frac{2}{5}, \frac{7}{10}, \frac{9}{40}$ (b) $\frac{17}{25}, \frac{23}{40}, \frac{67}{120}$

3. Arrange the fractions below in the ascending order of their values :

(a) $\frac{6}{7}, \frac{7}{9}, \frac{16}{21}, \frac{50}{63}$ (b) $\frac{65}{72}, \frac{31}{36}, \frac{53}{60}, \frac{17}{24}$

4. Arrange the fractions below in the descending order of their values :

(a) $\frac{3}{4}, \frac{6}{7}, \frac{7}{8}, \frac{5}{12}$ (b) $\frac{17}{25}, \frac{23}{40}, \frac{51}{65}, \frac{67}{130}$

5. Add :

(a) $\frac{5}{8} + \frac{3}{16}$ (b) $6 + 1\frac{6}{7}$ (c) $8\frac{5}{13} + 12\frac{7}{26}$

(d) 70 metre $9\frac{7}{10}$ cm + 80 metre $17\frac{3}{50}$ cm + 40 metre $27\frac{9}{25}$ cm

6. Subtract :

(a) $\frac{3}{8} - \frac{1}{7}$ (b) $8\frac{4}{15} - 7\frac{13}{45}$ (c) $20 - 9\frac{20}{21}$

(d) 25 kg $10\frac{1}{5}$ gm - 17 kg $7\frac{7}{25}$ gm

7. Simplify : (a) $7 - \frac{3}{8} + 8 - \frac{4}{7}$ (b) $9 - 3\frac{15}{16} - 2\frac{7}{8} + \frac{9}{32}$

(c) $2\frac{1}{2} - 4\frac{3}{5} - 11 + 17\frac{7}{15}$

8. Mr. Azmaine received $20\frac{1}{10}$ quintals of Aman, $30\frac{1}{20}$ quintals of Irri and $10\frac{1}{50}$ quintals of Aush paddy from his land in a year. How much paddy in quintal did he receive from his land in a year ?

9. Of a bamboo of 25 metre long, $5\frac{4}{25}$ metre is with black,

$7\frac{1}{4}$ metre is with red and $4\frac{3}{10}$ metre is with yellow colours.

What length in metres of the bamboo remains unpainted ?

10. Amina got $105\frac{7}{10}$ gm of gold from her mother and $98\frac{3}{5}$ gm of gold from her brother. How much of gold she should get from her father to make it 400 gm ?
11. Of the total distance, Zayed traversed $\frac{3}{10}$ part by rickshaw, $\frac{2}{5}$ part by bicycle, $\frac{1}{5}$ part on foot and the remaining 2 km path by horse cart. It takes an average of 5 minutes to traverse each km by rickshaw and bicycle.
- (a) Arrange $\frac{3}{10}$, $\frac{2}{5}$ and $\frac{1}{5}$ in the ascending order.
- (b) Determine the total distance of the traversed path.
- (c) How long did Zayed traverse by rickshaw and bicycle?

1.14 Multiplication of fractions

Multiplication of fractions by integer :

Multiplication of 7 by 3 means the addition of 7 three times. Similarly, $\frac{5}{13} \times 3$ means the addition of $\frac{5}{13}$ three times.

$$\text{i.e. } \frac{5}{13} \times 3 = \frac{5}{13} + \frac{5}{13} + \frac{5}{13} = \frac{5+5+5}{13} = \frac{15}{13}$$

$$\text{Observe : } \frac{5}{13} \times 3 = \frac{5 \times 3}{13} = \frac{15}{13}$$

$$\therefore \text{fraction} \times \text{integer} = \frac{\text{The numerator of the fraction} \times \text{integer}}{\text{The denominator of the fraction}}$$

Multiplication of a fraction by a fraction

$$\text{length} = \frac{5}{7} \text{ metre}$$

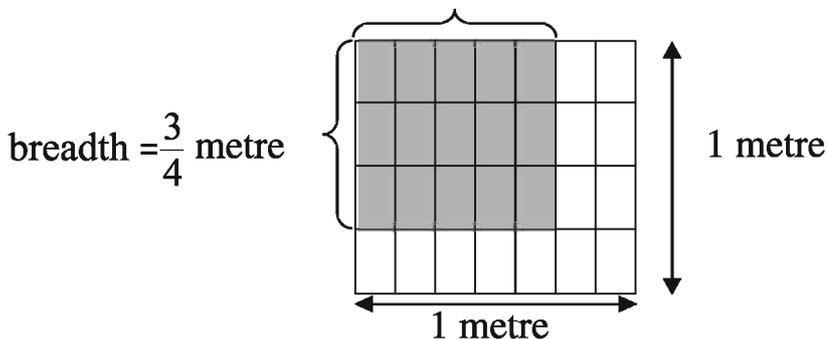

From the figure above, we observe :

- The area of the square = $1\text{m} \times 1\text{m} = 1 \text{ sq. m.}$
- The length of the square is divided into 7 parts and breadth is divided into 4 parts. That is why the whole square is divided into 28 rectangles. The area of each rectangle is $\frac{1}{28} \text{ sq. m.}$
- The length of the dark part is $\frac{5}{7} \text{ m.}$ and breadth is $\frac{3}{4} \text{ m.}$ whose area is $\left(\frac{5}{7} \times \frac{3}{4}\right) \text{ sq.m.}$
- Again, there are 15 small rectangles in the dark part. So the area of the dark part is = $\left(\frac{1}{28} \times 15\right) \text{ sq. m.} = \frac{15}{28} \text{ sq. m.}$

$$\therefore \frac{5}{7} \times \frac{3}{4} = \frac{15}{28} \text{ i.e. } \frac{5 \times 3}{7 \times 4} = \frac{15}{28}$$

\therefore The product of the two fractions =

$$\frac{\text{The product of the numerators of the two fractions}}{\text{The product of the denominators of the two fractions}}$$

Example 1. $2\frac{3}{7} \times 3\frac{2}{5} = ?$

Solution : $2\frac{3}{7} \times 3\frac{2}{5} = \frac{17}{7} \times \frac{17}{5}$ [expressing into improper fraction]

$$= \frac{17 \times 17}{7 \times 5} = \frac{289}{35} = 8\frac{9}{35}$$

The meaning of “of” :

$\left(12 \times \frac{3}{5}\right)$ is known as three-fifth of 12 or $\left(\frac{3}{5}\right)$ of 12).

i.e. $\frac{3}{5}$ of 12 = $12 \times \frac{3}{5}$

Example 2. $2\frac{11}{12}$ of $\frac{9}{35} = ?$

Solution : $2\frac{11}{12}$ of $\frac{9}{35} = \frac{9}{35} \times \frac{35}{12} = \frac{3}{4}$

1-15 Division of Fractions

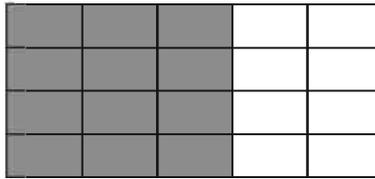

In the above figure, the region is divided into 20 equal parts, of which 12 parts are dark.

\therefore The dark part = $\frac{12}{20} = \frac{3}{5}$ part

In each row, the dark part = $\frac{3}{20}$ part of the region

In each row, the dark part = $\frac{1}{4}$ part of the total dark part

$$\begin{aligned} \therefore \text{The dark part in each row} &= \frac{1}{4} \text{ of the total dark part} \\ &= \frac{1}{4} \text{ part of the } \frac{3}{5} \text{ part of the whole region} \\ &= \left(\frac{1}{4} \text{ of } \frac{3}{5}\right) \text{ part of the whole region.} \end{aligned}$$

Observe : To divide $\frac{3}{5}$ by 4 refers to the same meaning as to multiply $\frac{3}{5}$ by $\frac{1}{4}$.

$\therefore \frac{3}{5} \div 4 = \frac{3}{5} \times \frac{1}{4}$; Here, reciprocal fraction of 4 is $\frac{1}{4}$.

To divide a fraction by another fraction, we need to multiply the first fraction by the reciprocal of the second fraction.

Example 3. $3\frac{5}{12} \div 2\frac{3}{8} = ?$

Solution : $3\frac{5}{12} \div 2\frac{3}{8} = \frac{41}{12} \div \frac{19}{8} = \frac{41}{12} \times \frac{8}{19} = \frac{82}{57} = 1\frac{25}{57}$

Activity :

Find the value of the fractions $5\frac{2}{7}$ and $1\frac{3}{14}$ using the sign of addition, sub-traction, multiplication, division and 'of' in between them.

Example 4. A man gave $\frac{1}{8}$ part of his property to his wife, $\frac{1}{2}$ part to his son and $\frac{1}{4}$ part to his daughter. The value of the rest of his property is Tk. 60,000. Determine the value of his total property.

Solution : The property the man gave his wife, son and daughter from his total property. $= \frac{1+4+2}{8}$ part $= \frac{7}{8}$ part

\therefore If his total property is 1 part, then rest of the property that remains to him is $1 - \frac{7}{8}$ part or $\frac{8-7}{8}$ part or $\frac{1}{8}$ part

As per question, Value of $\frac{1}{8}$ part of his property = Tk. 60,000

\therefore Value of total part = Tk. $60000 \div \frac{1}{8}$ or Tk. $60000 \times \frac{8}{1}$ or Tk. 4,80,000

\therefore The value of total property is Tk. 4,80,000.

1.16 Factors and Multiples of Fraction

Let us consider two fractions whose quotient is an integer.

$$\frac{4}{3} \div \frac{2}{9} = \frac{4}{3} \times \frac{9}{2} = 6$$

We can say, $\frac{4}{3}$ is exactly divisible by $\frac{2}{9}$. In this case the first fraction is known as the multiple of the second fraction and the second fraction is the factor of the first. A fraction has an infinite number of factors.

The denominators of $\frac{4}{5}$, $\frac{8}{15}$, $\frac{2}{3}$ are 5, 15, 3 respectively.

The L.C.M. of 5, 15 and 3 is 15. The reciprocal fraction of the L.C.M. 15 is

$$\frac{1}{15}$$

Now, we divide each of the fractions separately by $\frac{1}{15}$.

$$\frac{4}{5} \div \frac{1}{15} = \frac{4}{5} \times \frac{15}{1} = 12, \quad \frac{8}{15} \div \frac{1}{15} = \frac{8}{15} \times \frac{15}{1} = 8 \quad \text{and} \quad \frac{2}{3} \div \frac{1}{15} = \frac{2}{3} \times \frac{15}{1} = 10$$

We see that each of the fractions $\frac{4}{5}$, $\frac{8}{15}$ and $\frac{2}{3}$ is divisible by $\frac{1}{15}$;

$$\therefore \frac{1}{15} \text{ is the factor of each of } \frac{4}{5}, \frac{8}{15}, \frac{2}{3}.$$

Again, the numerators of the fraction $\frac{4}{5}$, $\frac{8}{15}$, $\frac{2}{3}$ are 4, 8, 2. The H.C.F. of 4, 8, 2 is 2 and the L.C.M. of the denominators 5, 15 and 3 is 15.

Now, dividing $\frac{4}{5}$, $\frac{8}{15}$ and $\frac{2}{3}$ separately by $\frac{2}{15}$, we get,

$$\frac{4}{5} \div \frac{2}{15} = \frac{4}{5} \times \frac{15}{2} = 6, \quad \frac{8}{15} \div \frac{2}{15} = \frac{8}{15} \times \frac{15}{2} = 4 \quad \text{and} \quad \frac{2}{3} \div \frac{2}{15} = \frac{2}{3} \times \frac{15}{2} = 5$$

\therefore All the fractions are divisible by $\frac{2}{15}$. Therefore, $\frac{2}{15}$ is also a factor of the fractions $\frac{4}{5}$, $\frac{8}{15}$ and $\frac{2}{3}$.

Observe

- (1) The numerator of the factor fraction is common factor of the numerators of the given fractions.
- (2) The denominator of the factor fraction is the common multiple of the denominators of the given fractions.

\therefore A common factor of the given fractions

$$= \frac{\text{a common factor of the numerators of the given fractions}}{\text{a common multiple of the denominators of the given fractions.}}$$

Remarks : The given fractions may have more than one common factors.

1.17 H.C.F. of Fractions

From the above discussion about common factors we get that $\frac{1}{15}$ and $\frac{2}{15}$ are two common factors of $\frac{4}{5}$, $\frac{8}{15}$, $\frac{2}{3}$.

Here, $\frac{2}{15} > \frac{1}{15}$ i.e. among the common factors of $\frac{4}{5}$, $\frac{8}{15}$, $\frac{2}{3}$; $\frac{2}{15}$ is the greatest.

\therefore The H.C.F. of $\frac{4}{5}$, $\frac{8}{15}$, $\frac{2}{3}$ is $\frac{2}{15}$.

\therefore The H.C.F. of the given fractions = $\frac{\text{The H.C.F. of the numerators of the given fractions}}{\text{The L.C.M. of the denominators of the given fractions.}}$

Activity :

1. Determine all the common factors of $\frac{5}{7}$ and $\frac{15}{21}$.
2. Determine H.C.F. of the fractions $2\frac{1}{4}$, $\frac{3}{16}$, $\frac{9}{20}$.

Example 5. What is the greatest number which gives an integer as quotient when $\frac{5}{32}$, $\frac{7}{80}$ and $5\frac{7}{16}$ are divided by that number ?

Solution: The required greatest number will be the H.C.F. of $\frac{5}{32}$, $\frac{7}{80}$ and $5\frac{7}{16}$.

Here, $5\frac{7}{16} = \frac{87}{16}$

The numerators of the fractions $\frac{5}{32}$, $\frac{7}{80}$ and $\frac{87}{16}$ are 5, 7, 87. The H.C.F. of 5, 7, 87 = 1

and the L.C.M. of the denominators 32, 80, 16 = 160

\therefore the H.C.F. of fractions = $\frac{\text{H.C.F. of the numerators}}{\text{L.C.M. of the denominators}} = \frac{1}{160}$

Required greatest number is $\frac{1}{160}$

Common multiples of fractions :

The H.C.F. of the denominators 4, 16, 20 of the fractions $\frac{1}{4}$, $\frac{3}{16}$, $\frac{9}{20}$ is 4 and the L.C.M. of the numerators 1, 3, 9 is 9

Now, we consider a fraction $\frac{9}{4}$, whose denominator is the H.C.F. of the denominators of the given fractions and the numerator is the L.C.M. of the numerators of the given fractions.

If we divide $\frac{1}{4}$, $\frac{3}{16}$, $\frac{9}{20}$ by $\frac{9}{4}$ respectively, we get

$\frac{9}{4} \div \frac{1}{4} = \frac{9}{4} \times \frac{4}{1} = 9$; $\frac{9}{4} \div \frac{3}{16} = \frac{9}{4} \times \frac{16}{3} = 12$ and $\frac{9}{4} \div \frac{9}{20} = \frac{9}{4} \times \frac{20}{9} = 5$

$\therefore \frac{9}{4}$ is the common multiple of $\frac{1}{4}, \frac{3}{16}, \frac{9}{20}$.

Common Multiples of the given fractions

$$= \frac{\text{a common multiple of the numerators of the given fractions}}{\text{a common factor of the denominators of the given fractions}}$$

1.18 L.C.M. of fractions

$\frac{9}{4}$ is a common multiple of the fractions $\frac{1}{4}, \frac{3}{16}, \frac{9}{20}$ as discussed earlier.

Again, multiples of $\frac{9}{4}$ are $\frac{18}{4}, \frac{27}{4}, \frac{36}{4}$ etc.

But $\frac{9}{4} < \frac{18}{4} < \frac{27}{4} < \frac{36}{4}$ etc.

i.e. $\frac{9}{4}$ is the smallest common multiple of the fractions $\frac{1}{4}, \frac{3}{16}, \frac{9}{20}$

\therefore **The L.C.M. of the given fractions** = $\frac{\text{L.C.M. of the numerators of the fractions}}{\text{H.C.F. of the denominators of the fractions}}$.

Activity : 1. Find out 5 common multiples of the fractions $\frac{2}{3}, \frac{6}{7}, \frac{4}{15}$.
2. Determine the L.C.M of the fractions $1\frac{3}{14}, 3\frac{3}{7}, 17\frac{1}{7}$.

Example 6. Which smallest number is exactly divisible by $7\frac{1}{5}, 2\frac{22}{25}$ and $5\frac{19}{25}$?

Solution : The given fractions are $7\frac{1}{5}, 2\frac{22}{25}, 5\frac{19}{25}$ i.e., $\frac{36}{5}, \frac{72}{25}, \frac{144}{25}$

Required smallest number will be the L.C.M. of $7\frac{1}{5}, 2\frac{22}{25}$ and $5\frac{19}{25}$.

The L.C.M. of the numerator of the fractions 36, 72, 144 is 144

The H.C.F. of the denominators of the fractions 5, 25, 25 is 5

\therefore The L.C.M. of $\frac{36}{5}, \frac{72}{25}, \frac{144}{25} = \frac{\text{The L.C.M. of numerators}}{\text{The H.C.F. of denominators}} = \frac{144}{5} = 28\frac{4}{5}$

Required smallest number is $28\frac{4}{5}$.

1-19 Simplification of Fractions

The order that must be followed in case of simplification is : Brackets, Of, Division, Multiplication, Addition and Subtraction. Again, among the brackets, the operation of the first (), second { } and the third [] brackets should be done similarly. If there is no sign just before the brackets, a presence of 'OF' is considered there.

It is convenient to remember the acronym 'BODMAS' formed with the initial letter of all operations in doing simplification.

Example 7. Simplify : $1\frac{3}{4} - \frac{3}{4}$ of $\frac{1}{3} \div \frac{5}{8} - 3\frac{1}{2} + 2\frac{1}{4}$

$$\begin{aligned} \text{Solution : } 1\frac{3}{4} - \frac{3}{4} \text{ of } \frac{1}{3} \div \frac{5}{8} - 3\frac{1}{2} + 2\frac{1}{4} &= \frac{7}{4} - \frac{3}{4} \text{ of } \frac{1}{3} \div \frac{5}{8} - \frac{7}{2} + \frac{9}{4} \\ &= \frac{7}{4} - \frac{1}{4} \div \frac{5}{8} - \frac{7}{2} + \frac{9}{4} = \frac{7}{4} - \frac{1}{4} \times \frac{8}{5} - \frac{7}{2} + \frac{9}{4} = \frac{7}{4} - \frac{2}{5} - \frac{7}{2} + \frac{9}{4} \\ &= \frac{35 - 8 - 70 + 45}{20} = \frac{80 - 78}{20} = \frac{2}{20} = \frac{1}{10} \end{aligned}$$

Example 8. Simplify : $\frac{3}{5} \left[4 - \frac{1}{4} \left\{ 4 - \frac{2}{5} \left(4 - \frac{1}{2} - \frac{1}{6} \right) \right\} \right]$

$$\begin{aligned} \text{Solution : } \frac{3}{5} \left[4 - \frac{1}{4} \left\{ 4 - \frac{2}{5} \left(4 - \frac{1}{2} - \frac{1}{6} \right) \right\} \right] \\ &= \frac{3}{5} \left[4 - \frac{1}{4} \left\{ 4 - \frac{2}{5} \left(4 - \frac{3+1}{6} \right) \right\} \right] = \frac{3}{5} \left[4 - \frac{1}{4} \left\{ 4 - \frac{2}{5} \left(4 - \frac{4}{6} \right) \right\} \right] \\ &= \frac{3}{5} \left[4 - \frac{1}{4} \left\{ 4 - \frac{2}{5} \left(\frac{24-4}{6} \right) \right\} \right] = \frac{3}{5} \left[4 - \frac{1}{4} \left\{ 4 - \frac{2}{5} \text{ of } \frac{20}{6} \right\} \right] \\ &= \frac{3}{5} \left[4 - \frac{1}{4} \left\{ 4 - \frac{4}{3} \right\} \right] = \frac{3}{5} \left[4 - \frac{1}{4} \left\{ \frac{12-4}{3} \right\} \right] \\ &= \frac{3}{5} \left[4 - \frac{1}{4} \text{ of } \frac{8}{3} \right] = \frac{3}{5} \left[4 - \frac{2}{3} \right] = \frac{3}{5} \left[\frac{12-2}{3} \right] \\ &= \frac{3}{5} \text{ of } \frac{10}{3} = \frac{2}{1} = 2 \end{aligned}$$

Exercise 1.5

- Multiply : (a) $2\frac{3}{5} \times 1\frac{7}{13}$ (b) $4\frac{1}{3} \times \frac{27}{32} \times 4\frac{7}{26}$ (c) $99\frac{3}{4} \times \frac{2}{17} \times \frac{5}{19}$
- Divide : (a) $5 \div \frac{15}{16}$ (b) $\frac{27}{32} \div 4\frac{7}{26}$ (c) $27\frac{3}{4} \div 14\frac{4}{5}$
- Simplify :
 (a) $1\frac{2}{3}$ of $\frac{1}{5} \div \frac{1}{9}$ (b) $3\frac{2}{3} \times \frac{4}{5}$ of $4\frac{7}{12}$ (c) $\frac{1}{2} \div \frac{3}{4}$ of $\frac{8}{9} \times 1\frac{4}{5}$
- Determine H.C.F. :
 (a) $2\frac{1}{2}, 3\frac{1}{3}$ (b) $8, 2\frac{2}{5}, \frac{8}{10}$ (c) $9\frac{1}{3}, 5\frac{2}{5}, 15\frac{3}{4}$
- Determine L.C.M. :
 (a) $5\frac{1}{4}, 1\frac{1}{8}$ (b) $3, \frac{24}{38}, \frac{15}{34}$ (c) $2\frac{2}{5}, 7\frac{1}{5}, 2\frac{22}{25}$
- Mr. Zamal is the owner of $\frac{7}{18}$ part of his father's property. He gave $\frac{5}{6}$ part of his property to his 3 children equally. Find out the amount of property of each of his children.
- The product of two fractions is $48\frac{1}{8}$. If one of the fractions is $1\frac{13}{32}$, find the other fraction.
- The weight of a bucket full of water is $16\frac{1}{2}$ kg. If $\frac{1}{4}$ of the bucket contains water weighing $5\frac{1}{4}$ kg, determine the weight of the empty bucket.
- Show that, the product of the fractions $5\frac{1}{4}$ and $2\frac{1}{8}$ is equal to the product of their L.C.M. and H.C.M.

Simplify (from 10 to 15) :

10. $\frac{7}{8}$ of $\frac{4}{5} \div \frac{3}{4}$ of $\frac{9}{10} - \frac{1}{2} \times \frac{5}{9}$

11. $\left(3\frac{1}{2} \div 2\frac{1}{2} \times 1\frac{1}{2}\right) \div \left(3\frac{1}{2} \div 2\frac{1}{2} \text{ of } 1\frac{1}{2}\right)$
12. $1\frac{20}{23} \times \left[4\frac{5}{16} \div \left\{1\frac{3}{8} \text{ of } 5\frac{1}{2} + \left(\frac{5}{7} - \frac{3}{14}\right)\right\}\right]$
13. $\frac{2}{5} \times \left[\frac{5}{32} \times \left\{\left(3\frac{1}{3} + 8\frac{4}{9}\right) \div \left(6\frac{1}{12} - 3\frac{7}{8}\right)\right\} + 3\frac{1}{7} \div 4\frac{2}{5} \times 4\frac{2}{3}\right]$
14. $7\frac{1}{2} - \left[3\frac{1}{4} \div \left\{\frac{3}{4} - \frac{1}{3}\left(\frac{2}{3} - \frac{1}{6} + \frac{1}{8}\right)\right\}\right]$
15. $1\frac{5}{6} + 7\frac{1}{3} - \left[1\frac{3}{4} + \left\{3\frac{2}{3} - \left(6\frac{1}{2} - 2\frac{1}{3} \text{ of } 1\frac{1}{2} + \frac{3}{4}\right)\right\}\right]$

Decimal Fraction

1-20 Addition of decimal fractions

10.5, 2.08 and 16.745 are three decimal fractions. In 16.745 there is the digit ‘5’ in the position of the thousandth. There is no digit in the place of thousandth in the number 2.08. Also there is no significant digits in the place of thousandth and hundredth of the first number 10.5. So, we can write 2.08 as 2.080 and 10.5 as 10.500 and then arranging them one below another we get,

$$\begin{array}{r} 10.500 \\ 2.080 \\ \underline{16.745} \\ 29.325 \end{array}$$

∴ In case of addition of decimal numbers we need to arrange them in such a way that the decimal points remain one below the other according to their position.

Example 1. Add : 33.01 + 3.7 + 14.85

Solution :

$$\begin{array}{r} 33.01 \\ 3.70 \\ \underline{14.85} \\ 51.56 \end{array}$$

Alternative method : $33.01 + 3.7 + 14.85$

$$= \frac{3301}{100} + \frac{37}{10} + \frac{1485}{100} = \frac{3301 + 370 + 1485}{100}$$

$$= \frac{5156}{100} = 51.56$$

1.21 Subtraction of decimal fractions

Same with the case of addition of decimal fractions, we need to arrange the given fractions keeping the decimal points directly one below another and then we have to subtract them.

Example 2. Subtract 1.71 from 23.657.

Solution : By arranging the given numbers keeping the decimal points one below another according to their position , we get

$$\begin{array}{r} 23.657 \\ 1.710 \\ \hline 21.947 \end{array}$$

1.22 Multiplication of decimal fractions

Example 3. Multiply 0.0657 by 0.75.

$$\begin{array}{r} \text{Solution :} \quad 657 \\ \quad \quad \quad 75 \\ \quad \quad \quad 3285 \\ \quad \quad 45990 \\ \hline \quad \quad 49275 \end{array}$$

$$\therefore 0.0657 \times 0.75 = 0.049275$$

Observe :

- Firstly, the decimal points are avoided and the numbers are multiplied as in the ordinary multiplication of numbers. After omitting the decimal point from the multiplicand, the zero on its extreme left has been omitted.

- There are 4 digits in the multiplicand and 2 digits in the multiplier after the decimal point i.e. after total (4 + 2) or 6 digits in the multiplicand and the multiplier. The product is obtained by placing the decimal point on the left of 6 digits counting from the right side of the product.
- A zero (0) has been necessary to put decimal point on the left of 6 digits counting from the right of the product.

Alternative method : $.0657 \times .75$

$$\begin{aligned}
 &= \frac{657}{10000} \times \frac{75}{100} \quad [\text{Expressing decimal fractions into common fractions}] \\
 &= \frac{657 \times 75}{10000 \times 100} = \frac{49275}{1000000} \\
 &= .049275 \quad [\text{Expressing in decimal fraction}]
 \end{aligned}$$

1.23 Division of decimal fractions

Example 4. Divide 808.9 by 25.

Solution :

$$\begin{array}{r}
 25 \overline{) 808.9} \quad (32.356 \\
 \underline{75} \\
 58 \\
 \underline{50} \\
 89 \\
 \underline{75} \\
 140 \\
 \underline{125} \\
 150 \\
 \underline{150} \\
 0
 \end{array}$$

Alternative method :

Solution : $808.9 \div 25$

$$\begin{aligned}
 &= \frac{808.9}{25} = \frac{808.9 \times 4}{25 \times 4} = \frac{3235.6}{100} \\
 &= 32.356
 \end{aligned}$$

Required quotient is 32.356.

Observe :

- Division has been carried on as in the case of division of integers.
- The decimal point has been inserted in the quotient just after the completion of division of integral part, because the decimal part have been divided.
- The process of division is performed placing zero on the right of the remainder.

1.24 H.C.F. and L.C.M. of decimal fractions

Determination of H.C.F. and L.C.M. of 2, 1.2 and 0.08

Given fractions are exactly equal to 2.00, 1.20 and 0.08

Now, H.C.F. of 200, 120 and 8 is = 8 and L.C.M. = 600

∴ The required H.C.F. = 0.08 and the L.C.M. = 6.00

Observe :

In some cases, necessary zeroes are put in the given decimal fractions in order to make the number of digits equal after the decimal point. Then the H.C.F. and the L.C.M. of the fractions are determined considering them a whole number. After that, decimal points are to be put in the obtained H.C.F. and L.C.M. after as many digits from its right as there are in each of the changed decimal fractions after their decimal points. Then we will get our required H.C.F. and L.C.M.

Alternative method

Expressing the given numbers in their lowest common fractions, we get,

$$2 = \frac{2}{1}, 1.2 = \frac{12}{10} = \frac{6}{5} \text{ and } .08 = \frac{8}{100} = \frac{2}{25}$$

H.C.F. of numerator 2, 6 and 2 of the fraction = 2 and L.C.M. = 6 and L.C.M. of denominator 1, 5 and 25 of the fractions = 25 and H.C.F. = 1

$$\therefore \text{H.C.F. of the fractions} = \frac{2}{25} = .08 \text{ and L.C.M} = \frac{6}{1} = 6.00$$

Example 5. Mr. Azim sold 50 quintals of rice at Tk. 30.75 per kg., 5 quintals of onion at Tk. 20.25 per kg. and 17 quintals of wheat at Tk. 17.50 per kg. He deposited an amount of Tk. 1,10,000.00 to a saving bank from the fund obtained. How much will be left with him ?

Solution : 1 quintals = 100 kg.

$$\therefore \text{Cost of 50 quintals of rice} = \text{Tk. } (30.75 \times 100 \times 50) = \text{Tk. } 1,53,750.00$$

$$\therefore \text{Cost of 5 quintals of onion} = \text{Tk. } (20.25 \times 100 \times 5) = \text{Tk. } 10,125.00$$

$$\therefore \text{Cost of 17 quintals of wheat} = \text{Tk. } (17.50 \times 100 \times 17) = \text{Tk. } 29,750.00$$

∴ Mr. Azim got the amount in total

$$= \text{Tk. } (1,53,7505.00 + 10,125.00 + 29,750.00)$$

$$= \text{Tk. } 1,93,625.00$$

$$\therefore \text{The amount left with him is Tk. } (1,93,625.00 - 1,10,000.00)$$

$$= \text{Tk. } 83,625.00$$

Exercise 1.6

- How many prime numbers are there from 28 to 40 ?
(a) 3 (b) 4 (c) 5 (d) 6
- Which one of the following are co-prime pairs ?
(a) 12, 18 (b) 19, 38 (c) 22, 27 (d) 28, 35
- What is the H.C.F. of 12, 18 and 48 ?
(a) 3 (b) 6 (c) 8 (d) 12
- In the mathematical sentence $0.01 \times 0.002 \times \square = 0.000000006$,
which number should be in the \square ?
(a) 0.03 (b) 0.003 (c) 0.0003 (d) 0.00003

- How many digits are used in enumeration?
(a) 8 (b) 9 (c) 10 (d) 11

- In one digit natural numbers, there are
(i) 4 prime numbers
(ii) 4 composite numbers
(iii) 5 odd numbers

Which of the following is correct?

- (a) i and ii (b) i and iii (c) ii and iii (d) i, ii and iii

- The number 6435 is divisible by
(i) 3 (ii) 5 (iii) 9

Which of the following is correct?

- (a) i and ii (b) i and iii (c) ii and iii (d) i, ii and iii

In the light of the following information, answer questions 8 and 9

(24,
32)

two natural numbers are shown in the figure:

8. Which is the multiple of the greatest number in the picture?
 (a) 4 (b) 8 (c) 16 (d) 32
9. What is the highest common factor of the two numbers in the picture?
 (a) 8 (b) 4 (c) 2 (d) 1

In the light of the following information, answer questions 10 and 11

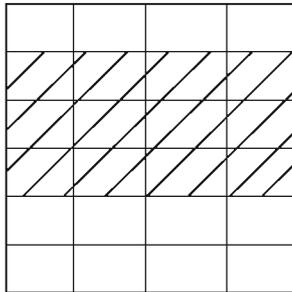

Figure : in the square figure each rectangle is equal

10. Into how many rectangles is the square divided ?
 (a) 1 (b) 4 (c) 6 (d) 24
11. How much part of the square is every rectangle?
 (a) $\frac{1}{4}$ part (b) $\frac{1}{6}$ part (c) $\frac{1}{8}$ part (d) $\frac{1}{24}$ part
12. Find the sum :
 (a) $0.325 + 2.368 + 1.2 + 0.29$
 (b) $13.001 + 23.01 + 0.005 + 80.6$
13. Find the difference :
 (a) $95.02 - 2.895$ (b) $3.15 - 1.6758$ (c) $899 - 23.987$

14. Multiply :

(a) $.218 \times 3$ (b) $.33 \times .02 \times .18$ (c) $.0754 \times 1000$ (d) $.05 \times .007 \times .0003$

15. Determine the quotient :

(a) $9.75 \div 25$ (b) $97.17 \div .0123$ (c) $.168 \div .0125$

16. Simplify :

$[3.5\{7.8 - 2.3 - (12.75 - 9.25)\}] \div .5$

17. Toma had Tk. 50. She gave her younger brother Tk. 15.50 and her friend Tk. 12.75. What amount of money was left with her ?

18. Parul Begum has 100 hundredths of land. She cultivated rice in 40.5 hundredths of it. Capsicum in 20.2 hundredths and potato in 10.75 hundredths. The rest of the part is used for the cultivation of brinjal. How much part of the land was used for cultivation of brinjal?

19. 1 inch = 2.54 cm. Then, 8.5 inch = cm ?

20. A car goes 45.6 km per hour. How much time will the car take to go 313.2 km ?

21. A teacher bought oranges of Tk. 722.15 at the rate of Tk. 60.60 a dozen and distributed the oranges among 13 of his students equally. How many oranges will each student get ?

22. 0.15 part of the total length of a bamboo is in the mud and 0.65 part is in water. If the length of the bamboo above water is 4 m., what is the length of the whole bamboo ?

23. Abdur Rahman gave .125 part of his property to his wife. He gave .50 part of the rest of the property to his son and .25 part to his daughter. After that he noticed, he was still left with property worth Tk. 3,15,000.00. What is the total value of Abdur Rahman's property ?

24. A farmer has 250 hundredths of land. He cultivated rice in $\frac{3}{8}$ part of it and vegetables in $\frac{5}{12}$ part of it. The rest of the land was kept uncultivated.
- (a) Find out the portion of the uncultivated land.
 - (b) If the selling price of rice is less than that of vegetables by Tk. 2400, what is the total amount of vegetables that he sold ?
 - (c) If he would cultivate rice in the whole part of the land, what amount of rice could he have sold ?

Chapter two

Ratios and Percentages

In our everyday life, we always compare the price, quantity etc. of one thing with those of another thing. That is, of more than one thing, we compare one thing to the other things in one way or another. Here comes ratio from this comparison. Again, we compare one thing to the parts, to how many times, or how many parts in percentage of other things. Usually we know of all these through ratio and percentage. So, we should have clear conception about ratio and percentage. On the other hand, there is a relation between Percentage and Fraction. In this chapter, all mentioned topics have been presented.

At the end of the chapter, the students will be able to

- explain what ratio is.
- solve the problems related to simple ratio.
- express percentage to fraction and fraction to percentage.
- express ratio to percentage and percentage to ratio.
- describe unitary method and the method of percentage accounting; and
- solve the arithmetic problems about time and work, time and food, time and distance with the help of unitary method and the method of percentage accounting.

2.1 Ratio

In our everyday life we often compare two things of the same kind. For example, if the height of Nabil is 150 cm and that of his sister is 140 cm, we can say that the height of Nabil is $(150 - 140)$ cm or 10 cm more than that of his sister. Thus we can make comparison by finding out the difference.

Again, if we want to compare the areas of two squares, comparing by differences of area is not justified. Rather, we can make justified comparison of the areas of two squares by finding out how many times a square is greater or smaller than the other. We can make this comparison by dividing the area of a square by that of the other. This comparison with division is called ratio. ‘ : ’ is the mathematical symbol of ratio.

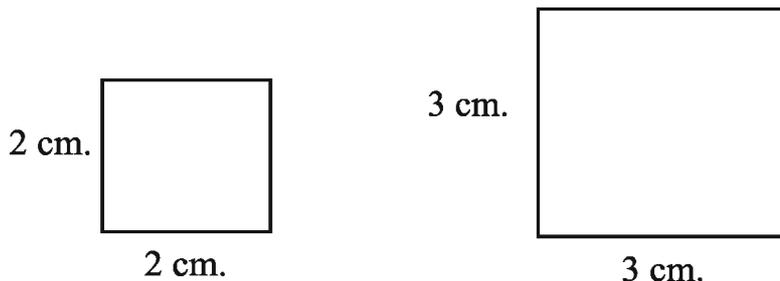

In the above figures, we see that there are two squares of areas 4 sq. cm and 9 sq. cm. The ratio of areas of the squares is $\frac{4}{9} = 4 : 9$ or $\frac{9}{4} = 9 : 4$ depending on which comes first. We see that ratio is a fraction. We observe the following examples :



- (a) The rectangular region is divided into 7 equal parts, 2 parts are white and the rest 5 parts are black. The ratio of white and black parts is 2 : 5 and here 2 and 5 are called antecedent and subsequent respectively.
- (b) Showkat’s weight is 30 kg and that of his father is 60 kg. How many times is the weight of father greater than that of Showkat ?
Ratio of the weights of father and Showkat is

$$\frac{60 \text{ kg}}{30 \text{ kg}} = \frac{2}{1} \quad [\text{Dividing the numerator \& denominator by 30}]$$

$$= 2 : 1$$

Here, the weight of father is twice the weight of Showkat.

- (c) In a class, there are 50 boys and 40 girls
Here, the ratio of the number of boys and girls is

$$\frac{50}{40} = \frac{5}{4} \quad [\text{dividing the numerator \& denominator by 10}]$$

$$= 5 : 4$$

Is it possible to compare the age of a child to the weight of a child ? It can never be done. To compare, two objects should be of the same kind. Further, let us suppose that the age of a baby is 6 years and that of another baby is 9 years 6 months. Though the ages are of the same kind, they can not be compared directly. The two objects should be of the same unit. In this case, the age of two babies should be expressed either in years or in months.

$$\begin{aligned} \text{Here, 6 years} &= (6 \times 12) \text{ months} = 72 \text{ months} (\because 1 \text{ year} = 12 \text{ months}) \\ 9 \text{ years 6 months} &= (9 \times 12 + 6) \text{ months} = 114 \text{ months.} \\ \text{So, the ratio of age of two babies is } &72 : 114 \text{ or } 12 : 19. \end{aligned}$$

Let us consider that the age of brother is 3 years and that of sister is 6 months. We shall have to find the ratio of their ages.

$$\begin{aligned} \text{Brother's age} &= 3 \text{ years} \\ &= 3 \times 12 \text{ months} (\because 1 \text{ year} = 12 \text{ months}) \\ &= 36 \text{ months} \end{aligned}$$

$$\text{Sister's age} = 6 \text{ months}$$

\therefore Ratio of their ages

$$\begin{aligned} &= \frac{36 \text{ months}}{6 \text{ months}} \text{ or } \frac{36}{6} \text{ or } \frac{6}{1} \quad [\text{Dividing numerator and denominator by 6}] \\ &= 6 : 1 \end{aligned}$$

Observe: It is to be noted that the different units can not be compared with each other. To compare, the units are to be of the same kind. Such as, the year has been converted into months in the above example.

Of two quantities of the same kind one is how many times or parts compared to the other can be expressed by fraction. This fraction is called ratio of two quantities. Since the two quantities are of the same kind, the ratio has no unit.

Activity :

1. Determine the ratio of numbers of your khatas and books.
2. Determine the ratio of breadth and length of your math book.
3. Determine the ratio of length and breadth of the table of your class.

2.2 Different Ratios

Equivalent Ratios

The value of a ratio remains unchanged when its antecedent and subsequent are multiplied or divided by any number except 0. Such ratios are called equivalent ratio.

$$\text{For example, } 2 : 5 = \frac{2}{5} = \frac{2 \times 2}{5 \times 2} = \frac{4}{10} = 4 : 10$$

\therefore 2 : 5 and 4 : 10 are equivalent ratios.

There are an infinite number of equivalent ratios of any ratio.

Such as , 2 : 3, 4 : 6, 6 : 9 and 8 : 12 are all equivalent ratios.

Again, in $1 : 2 = 5 : \square$, if we put 10 in the blanks, the ratio will be an equivalent ratio.

Observe :

- The ratio can be simplified if the terms of the ratio are divided by H.C.F. (Highest Common Factor).
- Each part of the ratio can be found if they are divided by the sum of the antecedent and subsequent of the ratio.

Example 1 : The ratio of age of Jesmin and Abida is 3:2. The present age ratio of Abida and Anika is 5:1. The present age of Anika is 3 years 6 months.

- (a) Express the first ratio in the stem into percentage.
- (b) What will be Abida's age after 5 years?
- (c) What is the percentage of Jesmin's present age to Anika's present age?

Solution:

$$\begin{aligned} \text{(a) The first ratio of the stem} &= 3:2 \\ &= \frac{3}{2} \\ &= \frac{3 \times 100}{2 \times 100} \\ &= \left(\frac{3 \times 100}{2} \right) \% \\ &= 150\% \end{aligned}$$

(b) Present age of Abida : present age of Anika = 5:1. It means Abida's present age is 5 times more than Anika's.

$$\begin{aligned} \text{Anika's present age} &= 3 \text{ years } 6 \text{ months} \\ &= (3 \times 12 + 6) \text{ months; } [\because 1 \text{ year} = 12 \text{ months}] \\ &= (36 + 6) \text{ months} \\ &= 42 \text{ months} \end{aligned}$$

$$\begin{aligned} \text{So, Abida's present age} &= (42 \times 5) \text{ months} \\ &= 210 \text{ months} \\ &= \frac{210}{12} \text{ years } [\because 12 \text{ months} = 1 \text{ year}] \\ &= \frac{210}{12} \text{ years} \\ &= \frac{35}{2} \text{ years,} \\ &= 17 \frac{1}{2} \text{ years.} \end{aligned}$$

\therefore after 5 years Abida's age will be

$$\begin{aligned} &= \left(17 \frac{1}{2} + 5\right) \text{ years} \\ &= 22 \frac{1}{2} \text{ years} \end{aligned}$$

(c) The ratio of ages of Jesmin and Abida is 3:2

It means Jesmin's present age is $\frac{3}{2}$ times more than Abida's present age.

From 'b' Abida's present age = $17 \frac{1}{2}$ years

$$\begin{aligned} \therefore \text{Jesmin's present age} &= 17 \frac{1}{2} \times \frac{3}{2} \\ &= \left(\frac{35}{2} \times \frac{3}{2}\right) \\ &= \frac{105}{4} \\ &= 26 \frac{1}{4} \text{ years} \end{aligned}$$

Anika's present age = 3 years 6 months

$$= 3 \frac{6}{12} \text{ years } [\because 1 \text{ year} = 12 \text{ months}]$$

$$= 3 \frac{1}{2} \text{ year}$$

$$= \frac{7}{2} \text{ year}$$

∴ Anika's present age is Jesmin's age's

$$= \left(\frac{7}{2} \div 26 \frac{1}{4} \right) \text{ portion}$$

$$= \left(\frac{7}{2} \times \frac{24}{15 \times 105} \right) \text{ portion}$$

$$= \frac{2}{15} \text{ portion}$$

$$= \left(\frac{2}{15} \times \frac{20}{100} \right) \%$$

$$= \frac{40}{3} \%,$$

$$= 13 \frac{1}{3} \%$$

So, Anika's present age is $13 \frac{1}{3} \%$ of Jesmin's present age.

Example 2. Divide Tk. 500 between two labours in the ratio 2 : 3.

Solution : The antecedent of the ratio is 2 and the subsequent of that is 3. The sum of two quantities is $2 + 3 = 5$.

∴ 1st labour will get $\frac{2}{5}$ times of Tk. 500 = Tk. 500 $\times \frac{2}{5}$ = Tk. 200

2nd labour will get $\frac{3}{5}$ times of Tk. 500 = Tk. 500 $\times \frac{3}{5}$ = Tk. 300

Activity :

1. If the age of Mamun is 4 years and that of his sister is 6 months, determine the ratio of their age.
2. The height of Sajal and Sujun are 1m 75 cm and 1m 50 cm respectively. Determine the ratio of their height.

Simple Ratio

The ratio of two quantities is called **simple ratio**.

The first quantity of simple ratio is called antecedent and the second quantity is called subsequent.

Such as, $3 : 5$ is a simple ratio. Here, 3 is antecedent and 5 is subsequent.

Ratio of less inequality

If the antecedent is smaller than the subsequent of a simple ratio, the ratio is called the **ratio of less inequality**. For example $3 : 5$ and $4 : 7$ both are the ratios of less inequality.

In a school, the average age of the students of class III is 8 years and that of the students of class V is 10.

Here, the ratio of the average ages of the students of class III and class V is $8 : 10$ or $4 : 5$.

The antecedent being smaller than the subsequent, it is called the **ratio of less inequality**.

Ratio of greater inequality

If the antecedent is greater than the subsequent of a simple ratio, it is called the **ratio of greater inequality**. Such as $5 : 3$, $7 : 4$ and $6 : 5$ all are the ratios of greater inequality.

Sadia bought a packet of biscuit by Tk. 32 and a cone ice-cream by Tk. 25. Here, the ratio of prices of biscuit and ice-cream is $32 : 25$. The antecedent 32 of this ratio being greater than the subsequent 25, it is the **ratio of greater inequality**.

Unit Ratio

The ratio in which the antecedent and the subsequent are equal is called **unit ratio**.

For example, Arif bought a ballpen by Tk. 15 and a khata by Tk. 15. Here, the prices of ballpen and khata are the same and the ratio of prices is $15 : 15$ or $1 : 1$. So, it is unit ratio.

Inverse Ratio

The ratio formed by interchanging the antecedent and subsequent of a simple ratio is called **inverse ratio**.

For example, $5 : 13$ is the inverse ratio of a simple ratio $13 : 5$.

Mixed or Compound Ratio

The ratio obtained by whose antecedent and subsequent are formed by the products of antecedents and subsequent of more than one simple ratio is called **mixed or compound ratio**.

Such as, the mixed ratio of simple ratios $2 : 3$ and $5 : 7$ is
 $(2 \times 5) : (3 \times 7) = 10 : 21$.

Example 3. Determine the compound ratio of the given simple ratios $5 : 7$, $4 : 9$,
 $3 : 2$.

Solution : The product of the antecedents of the given three ratios is

$$5 \times 4 \times 3 = 60.$$

and the product of subsequent is $7 \times 9 \times 2 = 126$

\therefore Required compound ratio is $60 : 126$ or $10 : 21$.

Activity :

- (1) Express as the inverse ratio of the simple ratio $4 : 9$
- (2) Determine the antecedents and subsequents of the following ratios
 (a) $4 : 11$ (b) $7 : 5$ (c) $19 : 21$.
- (3) Which one of the following is unit ratio ?
 (a) $2 : 5$ (b) $5 : 7$ (c) $11 : 11$
- (4) Divide the followings into the ratio of less inequality and the ratio of greater inequality :
 (a) $13 : 19$ (b) $7 : 12$ (c) $25 : 13$ (d) $27 : 7$
- (5) Determine the mixed ratio of the following ratios $2 : 3$ and $3 : 4$.

Example 4. The sum of two numbers is 360. If the ratio of the numbers is $4 : 5$, find the two numbers.

Solution : The ratio of numbers is $4 : 5$.

The sum of antecedent and subsequent is $4 + 5 = 9$.

$$\begin{aligned} \text{The first number} &= \frac{4}{9} \text{ times of } 360. \\ &= \frac{40}{\cancel{360}} \times \frac{4}{9} = 160. \end{aligned}$$

$$\begin{aligned} \text{The second number} &= \frac{5}{9} \text{ times of } 360. \\ &= \frac{40}{\cancel{360}} \times \frac{5}{9} = 200. \end{aligned}$$

Required two numbers are 160 and 200.

Example 5. In a mixture of 40 kg, the ratio of sand and cement is 4 : 1. Determine the quantity of sand and cement in the mixture.

Solution : The quantity of mixture is 40 kg. The ratio of sand and cement is 4 : 1. Here, the sum of antecedent and subsequent = 4 + 1 = 5.

$$\begin{aligned} \therefore \text{The quantity of sand} &= \frac{4}{5} \text{ times of } 40 \text{ kg} \\ &= \frac{4}{\cancel{5}^8} \times \frac{4}{\cancel{5}} \text{ kg} = 32 \text{ kg} \end{aligned}$$

$$\begin{aligned} \text{The quantity of cement} &= \frac{1}{5} \text{ times of } 40 \text{ kg} \\ &= \frac{1}{\cancel{5}^8} \times \frac{4}{\cancel{5}} \text{ kg} = 8 \text{ kg} \end{aligned}$$

Example 6. The ratio of numbers of boys and girls of a school is 5 : 7. If the number of girls is 350, what is the number of boys ?

Solution : Number of boys : Number of girls = 5 : 7

i.e. the number of boys is $\frac{5}{7}$ times of number of girls.

Given that the number of girls is 350

$$\therefore \text{Number of boys} = \frac{5}{\cancel{7}^{350}} \times \frac{350}{\cancel{7}} = 250$$

Required number of boys is 250.

Exercise 2.1

- Express the following pairs of number as the ratio of the first and second quantities :
 - 25 and 35
 - $7\frac{1}{3}$ and $9\frac{2}{5}$
 - 1 year 2 months and 7 months
 - 7 kg and 2 kg 300 gram
 - Tk. 2 and 40 paisa
- Simplify the following ratios.
 - 9 : 12
 - 15 : 21
 - 45 : 36
 - 65 : 26

3. Fill in the gaps of the following equivalent ratios :

(a) $2 : 3 = 8 : \square$ (b) $5 : 6 = \square : 36$ (c) $7 : \square = 42 : 54$

(d) $\square : 9 = 63 : 81$

4. The ratio of length and breadth of a hall room is 2 : 5. Putting the possible values of length and breadth in the gaps, complete the following table.

Breadth of hall room (m.)	10		40		160
Length of hall room (m.)	25	50		200	

5. Identify the equivalent ratios of the followings :

12 : 18; 6 : 18; 15 : 10; 3 : 2; 6 : 9; 2 : 3 ; 1 : 3; 2 : 6 ; 12 : 8

6. Express the following simple ratios into the mixed ratio :

(a) 3 : 5, 5 : 7 and 7 : 9 (b) 5 : 3, 7 : 5 and 9 : 7

7. Express the ratio 9 : 16 as inverse ratio.

8. Which one of the following ratios are unit ratios :

(a) 16 : 13 (b) 13 : 17 (c) 21 : 21

9. Divide Tk. 550 in the ratios of 5 : 6 and 4 : 7.

10. The ratio of the ages of father and son is 14 : 3. If the age of father is 56 years, what is the age of son ?

11. The sum of two numbers is 630. Their ratio is 10 : 11. Determine two numbers.

12. The ratio of the prices of two books is 5 : 7. If the price of the second book is 84, what is the price of the first book ?

13. In the golden ornaments of 20 grams of 18 carate the ratio of gold and alloy is 3 : 1. Determine the quantity of gold and alloy of those ornaments.

14. The ratio of time of coming and going to school from houses of two friends is 2 : 3. If the distance of school from the house of the first friend is 5 km., what is the distance of school from the house of the second friend ?

15. The ratio of milk and sugar in frumenty is 7 : 2. In the frumenty the quantity of sugar is 4 kg. What is the quantity of milk ?
16. The ratio of the prices of two computers is 5 : 6. If the price of the first computer is Tk. 25,000/-, what is the price of the second computer ?
In case of price hike if the price of the first computer is increased by Tk. 5,000/-, what type of ratio of their prices will be?

2.3 Relation between Ratio and Percentage

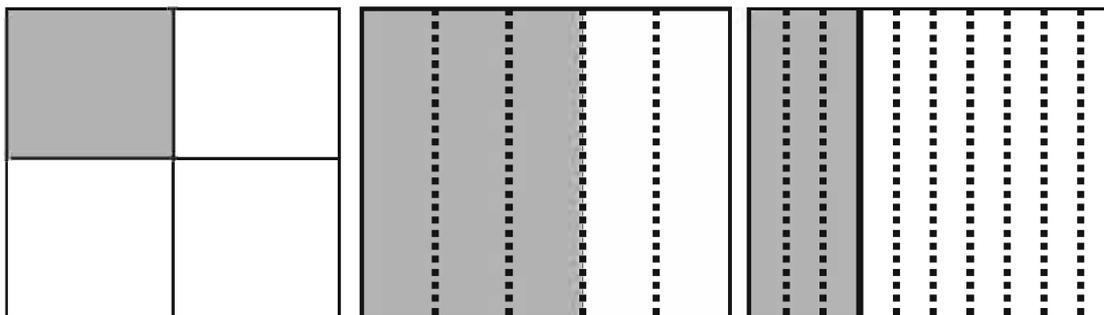

1 : 4

a

3 : 5

b

3 : 10

c

Of the above figures, $\frac{1}{4}$ parts of a, $\frac{3}{5}$ parts of b, and $\frac{3}{10}$ parts of c have been shaded.

Here, we see that,

in figure (a), the ratio of the shaded part and the whole part is

$$1 : 4 = \frac{1}{4} = \frac{1 \times 25}{4 \times 25} = \frac{25}{100} = 25\%$$

in figure (b), the ratio of the shaded part and the whole part is

$$3 : 5 = \frac{3}{5} = \frac{3 \times 20}{5 \times 20} = \frac{60}{100} = 60\%$$

in figure (c), the ratio of the shaded part and the whole part is

$$3 : 10 = \frac{3}{10} = \frac{3 \times 10}{10 \times 10} = \frac{30}{100} = 30\%$$

That is, 25%, 60%, 30% of the figures a, b, c are shaded respectively. It is seen that both percentage and ratio are fractions. But, in case of percentage, the denominator of the fraction is 100. In case of ratio numerator and the denominator may be of any natural number. If necessary, the percentage can be expressed into ratio and the ratio can be expressed into percentage. For example, the ratio of Tk. 7 and Tk. 10

$$= \frac{\text{Tk.7}}{\text{Tk.10}} = \frac{7}{10} = \frac{70}{100} = 70\%$$

Here, Tk. 7 is $\frac{7}{10}$ part of Tk.10 or $\frac{7}{10}$ times of Tk.10, which is equal to 70%.

On the other hand, percentage of 3 or 3% is $\frac{3}{100}$ or 3 : 100.

That is, a ratio can be expressed into percentage.

Activity :

1. Express the ratios 3 : 4 and 5 : 7 into percentage.
2. Express 5% and 12% into ratio.

Example 7. Express into ratios and decimals.

- (a) 15% (b) 32% (c) 25% (d) 55% (e) $8\frac{1}{10}\%$

Solution : (a) $15\% = \frac{15}{100} = \frac{3}{20} = 3 : 20 = .15$

$\therefore 15\% = 3 : 20 = .15$

(b) $32\% = \frac{\overset{8}{\cancel{32}}}{\underset{25}{100}} = \frac{8}{25} = 8 : 25 = .32$

$\therefore 32\% = 8 : 25 = .32$

(c) $25\% = \frac{25}{100} = \frac{1}{4} = 1 : 4 = .25$

$\therefore 25\% = 1 : 4 = .25$

$$(d) 55\% = \frac{55}{100} = \frac{11}{20} = 11 : 20 = .55$$

$$\therefore 55\% = 11 : 20 = .55$$

$$(e) 8\frac{1}{10}\% = \frac{81}{10}\% = \frac{81}{10} \times \frac{1}{100} = \frac{81}{1000} = 81 : 1000 = 0.081$$

$$\therefore 8\frac{1}{10}\% = 81 : 1000 = .081$$

Example 8. Express the following fractions into percentage.

$$(a) \frac{1}{4} \quad (b) \frac{3}{20} \quad (c) \frac{7}{15} \quad (d) \frac{4}{25} \quad (e) \frac{6}{13}$$

Solution : (a) $\frac{1}{4} = \frac{1 \times 100}{4 \times 100} = \frac{25}{100} = 25\%$

$$(b) \frac{3}{20} = \frac{3 \times 100}{20 \times 100} = \frac{15}{100} = 15\%$$

$$(c) \frac{7}{15} = \frac{7 \times 100}{15 \times 100} = \frac{140}{3} \times \frac{1}{100} = \frac{140}{3}\% = 46\frac{2}{3}\%$$

$$(d) \frac{4}{25} = \frac{4 \times 100}{25 \times 100} = \frac{16}{100} = 16\%$$

$$(e) \frac{3}{13} = \frac{3 \times 100}{13 \times 100} = \frac{300}{13} \times \frac{1}{100} = \frac{300}{13}\% = 23\frac{1}{13}\%$$

Example 9. One quantity is 50% of another quantity. Determine the ratio of two quantities.

Solution : $50\% = \frac{50}{100}$ that is, if one quantity is 50, the other will be 100.

$$\therefore \text{Ratio of 50 and 100 is } 50 : 100 = 1 : 2.$$

$$\therefore \text{Required ratio of two quantities} = 1 : 2.$$

Example 10. The sum of two quantities is 240. If their ratio is 1 : 3, find them. What is the percentage of the first quantity to the second ?

Solution : the Sum of two quantities = 240

Their ratio = 1 : 3

The sum of two quantities of the ratio = 1 + 3 = 4

$$\begin{aligned}\therefore \text{1st quantity} &= \frac{1}{4} \text{ times of } 240 \\ &= \frac{60}{\cancel{240}} \times \frac{1}{\cancel{4}} = 60\end{aligned}$$

$$\begin{aligned}\therefore \text{2nd quantity} &= \frac{3}{4} \text{ times of } 240 \\ &= \frac{60}{\cancel{240}} \times \frac{3}{\cancel{4}} = 180\end{aligned}$$

Again, ratio of two quantities is 1 : 3

$$\therefore \text{1st quantity} = \frac{1}{3} \text{ of 2nd quantity} = \frac{1 \times 100}{3 \times 100} = \frac{100}{3} \% = 33 \frac{1}{3} \%$$

$$\therefore \text{1st quantity is } 33 \frac{1}{3} \% \text{ of the second.}$$

Example 11. Monira has obtained 80% marks in the annual examinations. If the total marks of the examinations are 800, how many marks has Monira obtained ?

Solution : The marks obtained by Monira = 80% of 800 = $\frac{80}{100} \times 800 = 640$

\therefore the marks obtained by Monira is 640

Example 12. 180 fazley mangoes were bought from a fruits shop. After two days 9 mangoes rotted. How many mangoes are quite good ?

Solution : The total number of mangoes which were bought = 180.
the number of rotten mangoes = 9.

\therefore the number of good mangoes = 180 – 9 = 171.

The ratio of good mangoes and total mangoes is $\frac{171}{180} = \frac{19}{20}$

\therefore The percentage of good mangoes is $\frac{19 \times 100}{20} = 95\%$.

Exercise 2.2

- Express as percentage :
(a) $\frac{3}{4}$ (b) $\frac{7}{15}$ (c) $\frac{4}{5}$ (d) $2\frac{6}{25}$ (e) 0.25
(f) .65 (g) 2.50 (h) 3 : 10 (i) 12 : 25
- Express as fractions and decimals :
(a) 45% (b) $12\frac{1}{2}\%$ (c) $37\frac{1}{2}\%$ (d) $11\frac{1}{4}\%$
- Calculate the followings :
(a) 5% of 125 ? (b) 9% of 225 ?
(c) 6% of 6 kg rice ? (d) 40% of 200 cm ?
- (a) What is the percentage of Tk. 20 of Tk. 80 ?
(b) What is the percentage of Tk. 75 of Tk. 120 ?
- In a school, there are 500 students. If the girls are 40%, determine the number of boys ?
- David has obtained 600 marks out of 900 in the terminal examinations. What is the percentage of marks he has obtained? Determine the ratio of the total and the obtained marks.
- Musanna bought a Bengali essay book from book stall at Tk. 84. But the cover price of the book was Tk.120. How much commission in percentage has he obtained ?
- The monthly income of a service holder is Tk. 15,000/-. His monthly expenditure is Tk. 9000. What is the percentage of the expenditure to the income ?
- The monthly school fees of Shoeb are Tk. 200. His mother gives him Tk. 20 as tiffin expenses. What is the percentage of expenditure for his daily tiffin to the monthly school fees ?
- In a school, there are 800 students. At the beginning of the year, if 5% new students get admitted, what is the number of students at present in that school ?
- In a class, 5% students were absent out of 200 students. How many students were present ?
- Zahed, buying a book at 10% commission, gave Tk. 180 to the shopkeeper. What is the actual price of the book ?

13. Due to $14\frac{2}{7}\%$ fall in the price, 10 more bananas are available at Tk. 420.
- If $14\frac{2}{7}\%$ of a number is 10, determine the number.
 - What is the price of one dozen of banana at present?
 - To make a profit of $33\frac{1}{3}\%$, what should be selling price of each dozen of banana?

2.4 Unitary Method

Let the price of 10 ballpen be Tk. 50. Then, we can say easily that the price of one ballpen is Tk. $\frac{50}{10}$ or Tk. 5. Now, the price of any number of ballpens can be determined from that of one ballpen. Such as, the price of 8 ballpen is Tk. $(5 \times 8) =$ Tk. 40.

Therefore, in unitary method, we can determine the price, weight, quantity of the definite number of things from the price, weight, quantity of a single thing. Let us observe the following examples.

Example 13. If the price of 7 dozens of pencils is Tk. 1442, then what is the price of one dozen of pencil?

Solution : The price of 7 dozens of pencil is Tk. 1442

$$\therefore \text{ " " " 1 " " " " Tk. } \frac{1442}{7} \text{ or Tk. 206}$$

\therefore The price of one dozen of pencil is Tk. 206.

Let us observe that Tk. 1442 has been divided by 7 to find the price of 1 dozen of pencils.

Example 14. 10 persons can do a piece of work in 7 days. In how many days can 5 persons do the same work?

Solution : 10 persons can do the piece of work in 9 days

$$\therefore 1 \text{ " " " " " " " } 9 \times 10 \text{ days} = 90 \text{ days.}$$

In this case, the work done by one person needs 10 times time. That is, one person can do this work in 90 days. Now, if 5 persons do the work, the time needed is less than that of one person. That is, 5 persons can do the same work in $\frac{90}{5}$ days or 18 days.

Here, the time of one person is divided by 5, then we get the time of 5 persons.

Example 15. In a student mess of 50 students there is food for 4 days. How many days will do for 20 students with the same quantity of food ?

Solution : For 50 students the food lasts 4 days

$$\therefore \text{,, } 1 \text{ ,, ,, ,, ,, } (50 \times 4) \text{ days or 200 days}$$

$$\therefore \text{,, } 20 \text{ ,, ,, ,, ,, } \frac{50 \times 4}{20} \text{ days or 10 days}$$

Here, we see that the food of 50 students is enough for 4 days. The same quantity of food is enough for 200 days for one student. Again, it is enough for 20 students for 10 days. Thus it is seen that a reduced number of persons need more days; again an increased number of persons need less days.

Example 16. 20 workers can dig a pond in 15 days. How many workers can dig the pond in 20 days.

Solution :

In 15 days the pond is dug by 20 persons

$$\therefore \text{,, } 1 \text{ ,, ,, ,, ,, } 20 \times 15 \text{ ,,}$$

$$\therefore \text{,, } 20 \text{ ,, ,, ,, ,, } \frac{20 \times 15}{20} \text{ ,, or 15 persons}$$

The number of required workers is 15.

Example 17. Walking 10 hours daily, Shafique crosses 480 km in 12 days. In how many days can he cross 360 km walking 10 hours daily?

Solution : Walking 10 hours daily

Shafique crosses 480 km in 12 days

$$\therefore \quad \text{,,} \quad \text{,,} \quad 1 \text{ km.} \quad \text{,,} \quad \frac{12}{480} \quad \text{,,}$$

$$\therefore \quad \text{,,} \quad \text{,,} \quad 360 \text{ km.} \quad \text{,,} \quad \frac{12 \times 360}{480} \quad \text{,,} \quad \text{or 9 days}$$

\therefore Required time is 9 days.

Example 18. A and B can do a piece of work in 12 days and 20 days respectively. In how many days A and B together can do that piece of work ?

Solution : A in 12 days can do a piece of work

$$\therefore \quad \text{A} \quad \text{,,} \quad 1 \text{ day} \quad \text{,,} \quad \text{,,} \quad \frac{1}{12} \text{ part of a piece work}$$

Again , B in 20 days can do a piece of work

$$\therefore \quad \text{B} \quad \text{,,} \quad 1 \text{ day} \quad \text{,,} \quad \text{,,} \quad \frac{1}{20} \text{ parts of a piece work}$$

\therefore A & B together in 1 day can do $\left(\frac{1}{12} + \frac{1}{20} \right)$ part of a piece of work

$$= \frac{5+3}{60} \text{ part}$$

$$= \frac{8}{60} \text{ part}$$

$$= \frac{2}{15} \text{ part}$$

$$\begin{aligned} \therefore \text{ A and B can do } & \frac{2}{15} \text{ part of a piece of work in 1 day} \\ \therefore \text{ ,, ,, ,, ,, 1 part(total),, ,, } & 1 \div \frac{2}{15} \text{ or } 1 \times \frac{15}{2} \text{ days} \\ & = \frac{15}{2} \text{ days or } 7\frac{1}{2} \text{ days} \end{aligned}$$

Required time is $7\frac{1}{2}$ days.

Example 19. A 5-member family has provision for 20 days, with 40 kgs of rice. How many days will do for the same family with 70 kg of rice ?

Solution : For a 5-member family

40 kgs of rice is enough for 20 days

1 kg ,, ,, ,, $\frac{20}{40}$,,

$$\therefore 70 \text{ kgs of ,, ,, ,, } \frac{20 \times 70}{40} \text{ days or } 35 \text{ days}$$

Required time is 35 days.

Example 20 : A contractor made an agreement to complete a 100 km road in 20 days. Recruiting 250 labourers, he completed 62.5% construction work of the road in 10 days.

- (a) If the first quantity is 62.5% of the second quantity, what will be second quantity : first quantity = ?
- (b) If 100 labourers were recruited, how many kilometres of road would be constructed in 15 days?
- (c) Show that the work will be finished ahead of 4 days of the scheduled time.

Solution :

a. Here, $62.50\% =$

$$\frac{62.50\%}{100} = \frac{6250}{10000} = \frac{5}{8}$$

It means, the 1st quantity is $\frac{5}{8}$ portion of the 2nd quantity.
 If the 1st quantity is 5, the 2nd quantity will be 8
 the 2nd quantity : the 1st quantity = 8:5

b. Here, 62.50% of 100 km

$$= \frac{100 \times 62.50}{100} \text{ km}$$

$$= 62.50 \text{ km}$$

∴ 250 labourers in 10 days completed 62.50 km of road.

∴ 1 labourer in 10 days completes $\frac{62.50}{250}$ km of road

∴ 1 labourer in 1 day completes $\frac{62.50}{200 \times 10}$ km of road

∴ 100 labourers in 15 days complete $\frac{62.50 \times 100 \times 15}{250 \times 10}$ km of road

$$= \frac{93750}{2500} \text{ km}$$

$$= 37.50 \text{ km}$$

If 100 labourers were recruited, 37.50 km of road would be constructed in 15 days.

(c) From 'b' we get, 62.50% of 100 km = 62.50 km
 100 labourers in 10 days construct 62.50 km of road
 Remains (100-62.50) km of road
 = 37.50 km of road

Time remains (20-10) days or, 10 days

∴ 250 labourers construct 62.50 km of road in 10 days.

∴ 250 labourers construct 1 km of road in $\frac{10}{62.50}$ days.

∴ 250 labourers construct 37.5 km of road in $\frac{10 \times 37.50}{62.50}$ days.

$$= \frac{3750^6}{625} = 6$$

∴ The work will be finished (10-6) or 4 days ahead of the schedule time. (shown)

Exercise 2.3

1. In the following chart, match the expressions of the left to that of the right.

(a) Ratio	(a) %
(b) Unit ratio	(b) a fraction
(c) Symbol of percentage	(c) 1 : 5
(d) Ratio in greater inequality	(d) 9 : 9
(e) Ratio in less inequality	(e) 7 : 3

2. What is ratio ?
 a. A fraction b. An integer c. An odd number d. A prime number
3. Which is the equivalent ratio of 2 : 5 of the followings ?
 a. 2 : 3 b. 4 : 9 c. 4 : 10 d. 5 : 2
4. Which of the following is the compound ratio of 3 : 4 and 4 : 5 ?
 a. 15 : 16 b. 12 : 20 c. 7 : 9 d. 12 : 16
5. If the ratio 3 : 20 is expressed into percentage, which of the following is correct?
 a. 3% b. 20% c. 15% d. 17%
6. 1% of 200 centimetre is –
 (a) 2 metre (b) 1 metre (c) 2 centimetre (d) 1 centimetre
7. In the ratio 1:5
 (i) the antecedent is 1 (ii) the subsequent is 5 (iii) the inverse ratio is 5:1 Which is the correct answer?
 (a) i and ii (b) i and iii (c) ii and iii (d) i, ii and iii
8. Of 100 boys and girls, if 60% is girls
 (i) the number of girls = 60
 (ii) the number of boys = 40
 (iii) the ratio of boys and girls = 3:2.

Which is the correct answer?

(a) i and ii (b) i and iii (c) ii and iii (d) i, ii and iii

Answer questions 9 and 10 in the light of the following information:

Each part of the following diagram is equal.

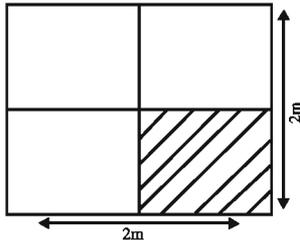

9. What is the ratio of the marked part and the whole part of the diagram?
 (a) 1:4 (b) 3:4 (c) 4:3 (d) 4:1
10. What is the area of the greatest square of the diagram?
 (a) 1 square metre (b) 2 square metre
 (c) 3 square metre (d) 4 square metre

Answer questions 11 and 12 using the following information.

2 men or 3 boys can finish a piece of work. 2 men, upon completing the work, got Tk. 900.

11. How many men's work can 9 boys do?
 (a) 4 persons (b) 6 persons (c) 8 persons (d) 12 persons
12. What amount of money would each boy get if 3 boys would do the work?
 (a) 1350 taka (b) 900 taka (c) 450 taka (d) 300 taka
13. Yousuf has obtained 70% of marks. What marks has Yousuf obtained if the total marks of examination are 700?
 a. 500 b. 490 c. 940 d. 904
14. What is the price of 5 kgs of rice if the price of 8 kgs of rice is Tk.168?
 a. Tk. 150 b. Tk. 105 c. Tk. 110 d. Tk. 125

15. What will be the price of 15 kgs of rice if the price of 7 kgs of rice is Tk.280 ?
16. In a hostel there was food stored for 50 students for 15 days. For how many days will 25 students be served by that quantity of food ?
17. A shopkeeper by investing Tk. 9000 makes a profit of Tk. 450 daily. How much money is to be invested if he wants to make a profit of Tk. 600 daily?
18. 10 persons can be served for 27 days with 120 kgs of rice. How many kgs of rice are needed to serve the same number of persons for 45 days ?
19. There are 2 quintals of rice for 15 students for 30 days. How many days will be required to serve 20 students with the same quantity of rice ?
20. There are 25 students living in a hostel. They need 625 gallons of water in a week. How many students will be able to fulfill their needs if there are 900 gallons of water ?
21. 9 workers can do a piece of work in 18 days. In how many days can 18 workers do that piece of work ?
22. 360 workers can construct an embankment in 25 days. How many extra workers are needed to finish the construction in 18 days ?
23. By working 6 hours daily 25 persons can do a piece of work in 8 days. In how many days can 10 persons finish the piece of work by working 6 hours daily ?
24. A school student crosses 10 km. in 2 hours by cycling from his house to school. How many kilometers does he run in 6 days and what is his speed ?
25. Walking 10 hours daily Rabin crosses 480 km in 12 days. In how many days can he cross 360 km walking 9 hours daily?
26. Jalal crosses 9 km path in each 3 hours. How many hours does he need to cross 36 km?

27. 6 workers can reap crops of a field in 28 days. In how many days will 24 workers reap the crops of that field ?
28. 2 men can do the same amount of work that 3 boys can do. 4 men and 10 boys together can do a piece of work in 21 days. In how many days will 6 men and 15 boys do that work ?
29. Alif can complete a piece of work in 20 days. Khalid can finish the same work in 30 days. Their daily wages are Tk. 500 and Tk. 400 respectively. After working 3 days together, Khalid completed the rest of the work alone.
- What part of work can Alif and Khalid do in 1 day?
 - In how many days did the work get finished?
 - If they each of them individually finish $\frac{5}{16}$ portion of the work, find out the ratio of the wages they are entitled to.

Chapter Three

Integers

With the advancement of civilization, different kinds of symbols were needed to maintain the accounts of a large number of animals and commodities. Counting system started from there and gradually the numerical symbols of this modern age have been shaped. At present all numbers in Mathematics are written with the ten symbols or digits : 1, 2, 3, 4, 5, 6, 7, 8, 9, 0. The absolute value of these digits is one, two, three, four, five, six, seven, eight, nine and zero respectively. In this chapter, we will get the idea of negative numbers. The representation of integers on number line, their comparisons and the procedure of their addition and subtraction will be discussed here.

At the end of the chapter, the students will be able to

- explain the characteristics of integers.
- identify integers.
- represent integers on number line and compare small integers with large ones.
- add and subtract signed numbers and represent those on number lines.

3.1 Concept of Negative Integers

Toma and Salma are playing a game using a number strip which is marked from 0 to 25 at equal intervals.

To begin with, each of them placed a token at the zero mark. Two coloured dice, one is red and the other is blue, are placed in a bag and are taken out by them one by one. If the dice is red in colour, the token is moved forward as per the number shown on throwing this dice. If it is blue, the token is moved backward as per the number shown when this dice is thrown. The dice is put back into the bag after each move so that both of them have equal chance of getting either dice. The number strip is marked from 0 to 25. Then what will happen to the token when the drawn dice is blue ?

Toma and Salma then finish the game after placing a similar blue number strip to the left of the previous one in the opposite direction.

The condition of finishing the game was that the one who reaches the 25th mark first is the winner.

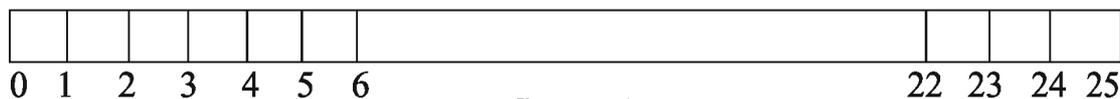

figure-1

Another day, they could find no blue number strip. But they played the game after placing two similar number strips in the opposite direction. According to their decision, they used a sign attached to the numbers on the left of zero. The sign that was used was a minus sign ‘-’. This indicates that numbers with a negative sign are less than zero. These are called negative numbers.

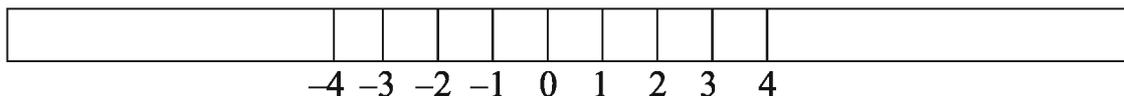

figure-2

3.2 Writing of Negative Numbers

Suppose Shipon and Raju have started walking from zero position to the opposite directions. Let the steps to the right of zero be represented by ‘+’ sign and that to the left of zero by ‘-’ sign. If Shipon moves 5 steps to the right of zero, it can be represented as +5 and if Raju moves 4 steps to the left of zero, it can be represented as - 4.

Activity :

Represent the following steps with ‘+’ or ‘-’ sign:

- 4 steps to the left of zero
- 7 steps to the right of zero
- 11 steps to the right of zero
- 6 steps to the left of zero.

3.3 Decreasing and Increasing of Number

We have seen from the previous examples that a number on the right is positive and that on the left is negative.

So, if a movement of only 1 is made to the right, we get the successor of the number. Similarly, if a movement of only 1 is made to the left, we get the predecessor of the number.

Activity :

Write the succeeding number of the following :

Number	Successor
10	
8	
-5	
-3	
0	
3	

Write the preceding number of the following :

Number	Predecessor
10	
8	
3	
0	
-3	
-6	

3.4 Use of Negative Numbers

So far, we have got the idea of negative numbers. Their use in real life are stated here.

Income
Expenditure

Profit
Loss

Increase
Decrease

We are familiar with the pair of words in each of the above boxes. The meaning of the first word of each pair is opposite to that of the second one. The words Income, Profit and Increase give us a positive notion whereas the other words give us a negative notion.

If the income of Tk. 5.00 is represented by +5, the spending of Tk.7.00 is represented by - 7. Similarly, if +6 means a profit of Tk. 6.00, - 4 means a loss of Tk. 4.00.

From the above discussion, it is clear that for two expressions of the same kind but of opposite meaning, if one of them is written with the (+) sign, the other is written with the (-) sign.

An expression with (+) sign is called a positive expression and that with (-) sign is called a negative expression. So, (+) and (-) signs are called the positive and the negative signs respectively.

Activity :

Explain the pair of words given below :

Deposit
Expenditure

Full
Empty

Cash
Dues

3.5 Integers

For the need of mankind, the numbers 1, 2, 3, were discovered.

These are also called natural numbers or positive whole numbers. If we include zero to the collection of natural numbers, we get a new collection of numbers known as whole numbers i.e. 0, 1, 2, 3, These are also called non-negative whole numbers. We also find that there are negative whole numbers too i.e. -4, -3, -2, -1.

If we put the non-negative whole numbers and the negative whole numbers together, the new collection of numbers will look like

..... -4, -3, -2, -1, 0, 1, 2, 3, 4,

These numbers are known as Integers.

Numbers can be expressed with the help of following figures :

	Natural numbers		Zero
	Non-negative integers		Negative integers
			Integers

figure – 3

3.6 Representation of integers on a number line

A straight line is drawn and a point 0 is taken on it. The point 0 divides the line into two segments. The segment on the right side and that on

the left side are extended boundlessly. Generally, the right side is considered as the positive direction and the left side as the negative direction.

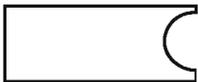
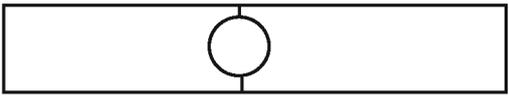
Taking a definite length as unit, equal segments are marked on both sides starting from the point 0. The marks on the right side are denoted by $+1, +2, +3, +4, \dots$ respectively and that on the left side are $-1, -2, -3, -4, \dots$ respectively. This line marked with numbers is known as number line.

Now, in order to mark $+2$ on the number line, we move 2 units to the right of zero and arrive at the point marked with 2 and differentiate it with a small black circle from the others. Then this point represents the integer 2 (figure-4).

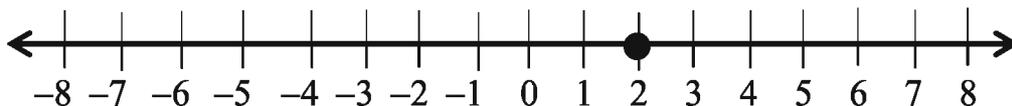

figure – 4

In order to mark -6 on this line, we move 6 units to the left of zero and arrive at the point marked with -6 . Then this point represents the integer -6 .

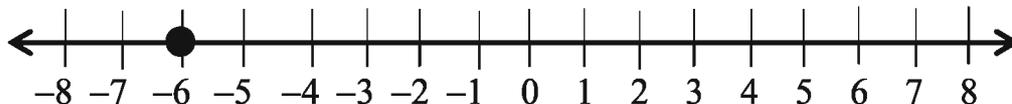

figure-5

3.7 Ordering of Integers

Rama and Rani live in a village where there is a pond with 10 steps down to the bottom of the pond. One day they went to the pond and counted 5 steps down to water level. They decided to see how much water would come in the pond during the rains. They marked zero at the existing level of water and marked 1, 2, 3, 4, 5 above that level for each step. After the rains they noted that the water level rose upto the third step. After a few months of the rainy season, they noticed that the water level had fallen three steps below the zero mark. Now, they started thinking about marking the steps to note the fall of water level.

Since the water level has gone below the initial level, they decided to mark them with numbers with minus sign. Accordingly, they marked the three steps below zero as -1 , -2 , -3 , respectively. After a few days, the water level went down by 1 step and they marked it with -4 . Now you can see that, $-4 < -3$. Similarly, we can say that $-5 < -4$.

Let us again observe the integers which are represented on the number line.

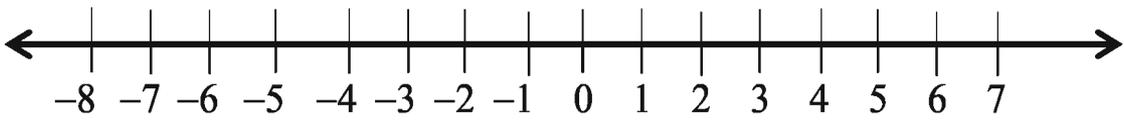

figure-6

We know that, $7 > 4$ and from the number line shown above, we observe that 7 is to the right of 4 (fig. 6). Similarly, $4 > 0$ means 4 is to the right of 0. Now, since 0 is to the right of -3 , $0 > -3$. Again, -3 is to the right of -8 , so $-3 > -8$.

Thus, the number increases as we move to the right and decreases as we move to the left.

Therefore, $-3 < -2$, $-2 < -1$, $-1 < 0$, $0 < 1$, $1 < 2$, $2 < 3$, and so on. Hence, integers can be written as, 5, 4, 3, -2 , -1 , 0, 1, 2, 3, 4, 5,

Activity :

- Write -5 , 7 , 8 , -3 , -1 , 2 , 1 , 9 according to the order.

Exercise 3.1

- Write the opposite of the following in meaning:
 - Increase in weight
 - 30 km north
 - The market is 8 km to the east of the home
 - Loss of Tk. 700
 - 100 m above sea level

2. Represent the numbers with appropriate signs in the following sentences.
 - (a) An aeroplane is flying at a height of two thousand metres above the ground.
 - (b) A submarine is moving at a depth of eight hundred metres below the sea level.
 - (c) A deposit of two hundred Taka in the bank.
 - (d) Withdrawal of seven hundred Taka from the bank.
3. Place the following numbers on number line:
 - (a) + 5
 - (b) -10
 - (c) +8
 - (d) -1
 - (e) -6
4. Following is the list of temperatures of four places of different countries on a particular day :

Name of the place	Temperature	Blank column
Dhaka	30°C above 0°C
Kathmandu	2°C below 0°C
Srinagar	5°C below 0°C
Ryad	40°C above 0°C

- (a) Write the temperatures of these places in the form of integers in the blank column.
- (b) Following is the number line representing the temperature.

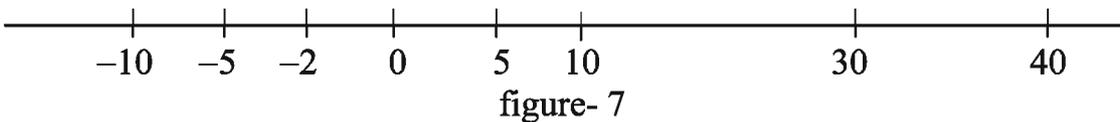

- (i) Put the name of city against its temperature .
- (ii) Which is the coolest place ?
- (iii) Write the names of the places where temperatures are above 10°C.

5. In each of the following pairs, which number is to the right of the other on the number line ?

- (a) 2, 9 (b) -3, -8 (c) 0, -1
 (d) -11, 10 (e) -6, 6 (f) 1, -10
6. Write all the integers between the given pairs in the increasing order.
- (a) 0 and -7 (b) -4 and 4
 (c) -4 and -15 (d) -30 and -23
7. (a) Write four negative integers greater than -20.
 (b) Write four negative integers less than -10.
 (c) Write four negative integers between -10 and -5.
8. For the following statements, write True (*T*) or False (*F*).
 If the statement is false, correct it.
- (a) -8 is to the right of -10 on a number line.
 (b) -70 is to the right of -60 on a number line.
 (c) Smallest negative integer is -1.
 (d) -26 is greater than -20.

3.8 Addition of Integers

In Shyama's house, there are stairs for getting on the roof of the house and for going down into the godown.

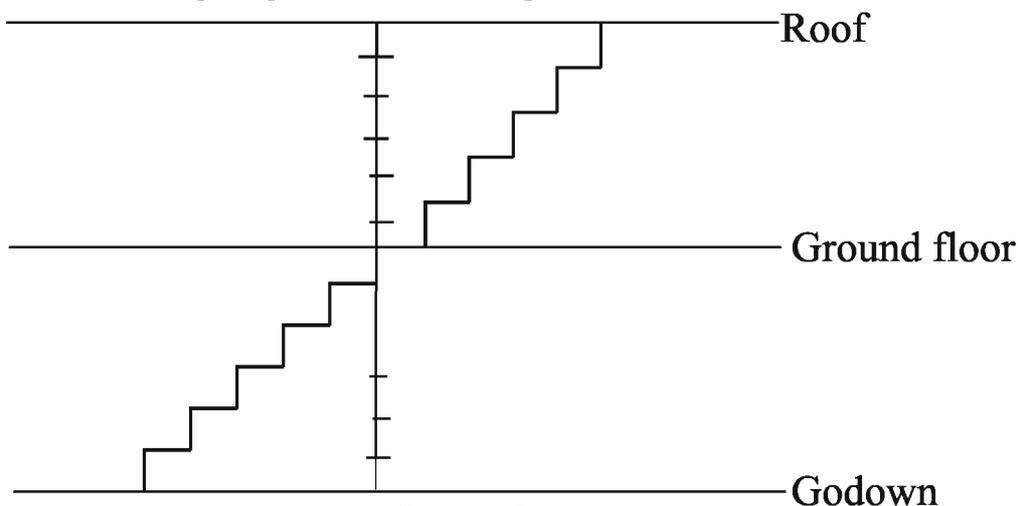

figure -8

Let us consider the number of stairs getting on the roof as positive integer, the number of stairs going down into the godown as negative integer and the number representing ground level as zero.

Read the following sentences and fill in the blank boxes with integers [two are worked out] :

- (a) Going 6 stairs up from the ground floor $\boxed{+6}$.
- (b) Going 5 stairs down from the ground floor then going up 7 stairs $\boxed{(-5) + (+7) = +2}$.
- (c) Going 4 stairs down from the ground floor $\boxed{}$.
- (d) Going 2 stairs up from the ground floor and then from there going up another 3 stairs $\boxed{}$.
- (e) Going 4 stairs down from the ground floor and then going down from there another 2 stairs $\boxed{}$.
- (f) To go down 5 stairs from the ground floor and then to move up to 3 stairs from there $\boxed{}$.
- (g) To go up 4 stairs from the ground floor and then to move down 8 stairs from there $\boxed{}$.

Activity :
 Draw a number line in a group. Then prepare some questions similar to those above and write their answers.
 Exchange the works of one group with those of the other one according to your class teacher's advice and then evaluate them.

3.9 Addition of integers with the help of a number line

(i) Addition of 5 and 3 with the help of a number line (i.e. to find $5+3$) :

First we draw a number line

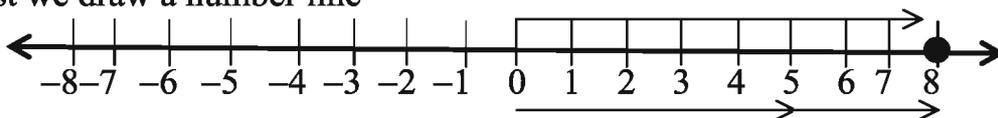
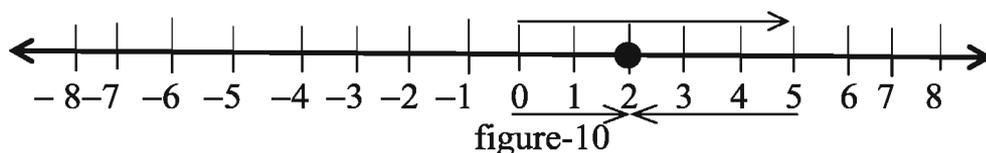

figure-9

On the number line, we first move 5 steps to the right from 0 reaching 5, then we move 3 steps to the right of 5 and reach 8. Thus, we get $5 + 3 = 8$ (figure 9).

(ii) Suppose we wish to find the sum of $(+5)$ and (-3) on the number line i.e to find $5 + (-3)$: First, we move to the right of 0 by 5 steps reaching 5. Then we move 3 steps to the left of 5 reaching 2. Thus, $(+5) + (-3) = 2$ (figure 10)



(iii) Let us find the sum of (-5) and $(+3)$ on the number line.

First, we move 5 steps to the left of 0 reaching -5 and then from this point we move 3 steps to the right. We reach the point -2 . Thus, $(-5) + (+3) = -2$ (figure 11).

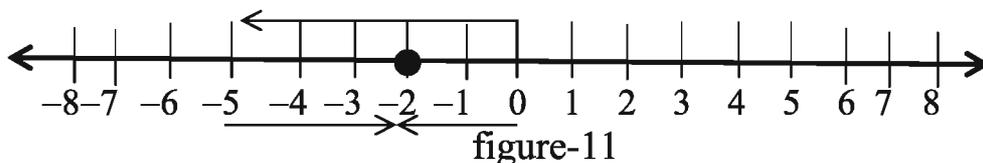

(iv) Let us add -5 and -3 on the number line.

On the number line, we first move 5 steps to the left of 0 reaching -5 , then we move 3 steps to the left of -3 and reach -8 . Thus, $(-5) + (-3) = -8$ (figure 12).

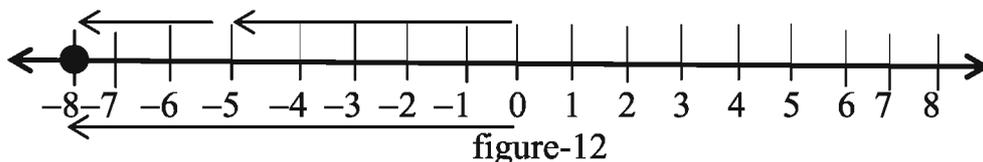

From above discussion, we see that when a positive integer is added to an integer, the resulting integer becomes greater than the given integer. When a negative integer is added to an integer, the resulting integer becomes less than the given integer.

Now let us find the sum of 3 and -3 . We first move from 0 to +3 and then from +3, we move 3 points to the left. Where do we reach ultimately ?

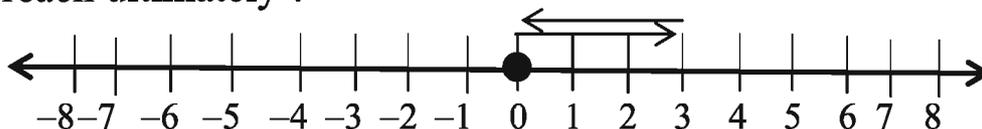

figure-13

From the figure 13, we see that $3+(-3) = 0$. That is, ultimately we have reached 0.

Since $(+3) + (-3) = 0$, +3 and -3 are called additive inverses of each other.

Activity :

1. Write some positive and negative integers. Then write their additive inverses and represent them on the number line.
2. Use number line to find the sum of (a) $(-2) + 6$ (b) $(-6) + 2$
Form another two similar problems and solve it using number line.

Example 1. Find the sum of $(-9) + (+4) + (-6)$.

Solution : We can arrange the numbers so that the negative integers are grouped together. We have,

$$\begin{aligned} & (-9) + (+4) + (-6) \\ &= (-9) + (-6) + (+4) \\ &= (-15) + (+4) = -15 + 4 \\ &= -11 \end{aligned}$$

Example 2. Find the value of $(+30) + (-23) + (-63) + (+55)$.

Solution : We can rearrange the numbers so that the positive integers and the negative integers are grouped together. We have

$$\begin{aligned} & (+30) + (-23) + (-63) + (+55) \\ &= (+30) + (+55) + (-23) + (-63) \\ &= (+85) + (-86) = 85 - 86 \\ &= -1 \end{aligned}$$

Example 3. Find the sum of -10 , 92 , 84 and -15 .

$$\begin{aligned} \text{Solution : } & -10 + 92 + 84 + -15 \\ & = -10 + -15 + 92 + 84 \\ & = -25 + 176 = 176 - 25 \\ & = 151 \end{aligned}$$

Activity :

Add the following without using number line : (a) $(+7) + (-11)$
 (b) $(-13) + (+10)$ (c) $(-7) + (+9)$ (d) $(+10) + (-5)$. Form another five problems of this type and solve these yourself without using number line.

Exercise 3.2

- Use number line and add the following :
 (a) $9 + (-6)$ (b) $5 + (-11)$ (c) $(-1) + (-7)$ (d) $(-5) + 10$
- Add without using number line :
 (a) $11 + (-7)$ (b) $(-13) + (+18)$ (c) $(-10) + (+19)$
 (d) $(-1) + (-2) + (-3)$ (e) $(-2) + 8 + (-4)$
- Add :
 (a) 137 and -35 (b) (-52) and 52
 (c) -31 , 39 and 19 (d) -50 , -200 and 300
- Find the sum :
 (a) $(-7) + (-9) + 4 + 16$ (b) $(37) + (-2) + (-65) + (-8)$

3.10 Subtraction of Integers with the help of a Number Line

We have added integers on a number line. In that case we find that, to add a positive integer we move towards the right on a number line and for adding a negative integer we move towards the left. Now, we shall learn how to subtract an integer from another integer

(a) Subtraction of 2 from 6 using number line i.e. to find $6 - (+2)$.

For subtracting 2 from 6, we would move 2 steps towards left from 6 on a number line and arrive at 4.

Therefore, we get $6 - (+2) = 6 - 2 = 4$ (figure 14)

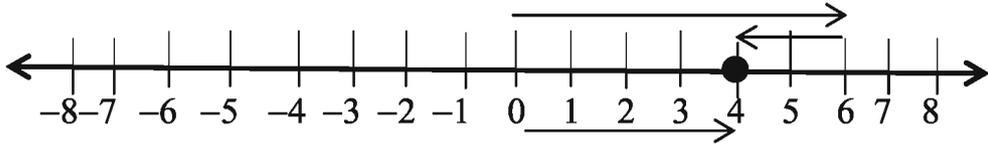

figure-14

(b) To subtract 2 from 6 i.e. to find $6 - (-2)$.

What would we do for $6 - (-2)$? Would we move towards the left on the number line or towards the right?

If we move 2 steps to the left, we reach 4. Then we have to say $6 - (-2) = 4$. This is not true because we know $6 - 2 = 4$. Hence, $6 - 2 \neq 6 - (-2)$.

So, we have to move 2 steps towards the right as we can move only to the left or right on a number line.

Hence we get $6 - (-2) = 8$. (figure 15)

Observe that, $-(-2) = +2 = 2$.

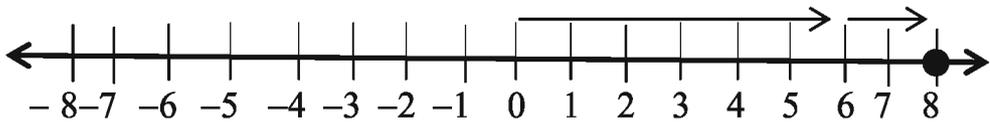

figure-15

We can consider this problem in another way. We know that additive inverse of (-2) is 2. Thus, it appears that adding the additive inverse of (-2) to 6 is the same as subtracting (-2) from 6.

Hence, we can write that $6 - (-2) = 6 + (\text{additive inverse of } -2)$.
 $= 6 + (+2) = 6 + 2 = 8$.

To subtract an integer from another integer it is enough to add the additive inverse of the integer that is being subtracted to the other integer.

From the above example, it is clear that when we subtract a negative integer from any integer, we get an integer greater than the one from which the other one is subtracted.

(c) Finding the value of $-5 - (+4)$ using number line.

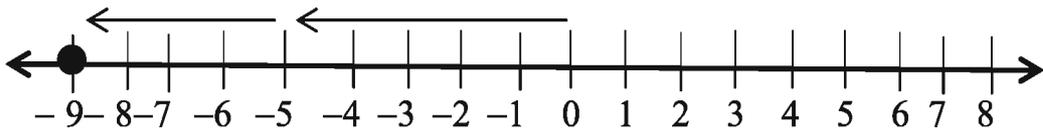

figure-16

We know that $-5 - (+4) = -5 + (-4)$, since the additive inverse of $+4$ is -4 . Now, to evaluate $-5 + (-4)$ we move 4 steps to the left of -5 and reach -9 . So, we get $-5 - (+4) = -9$.

(d) To evaluate $-5 - (-4)$ using number line.

We know that $-5 - (-4) = -5 + (+4) = -5 + 4$ as the additive inverse of -4 is $+4$.

To evaluate $-5 + 4$, we move 4 steps to the right of -5 and reach -1 .

Hence, we get, $-5 - (-4) = -1$. (figure 17)

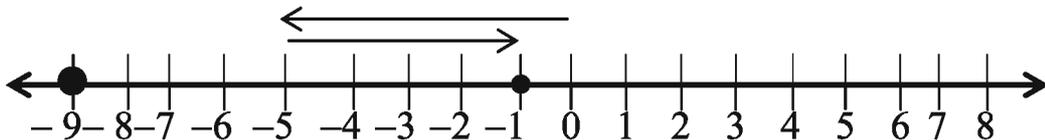

figure-17

Example 1. Find the value of $-8 - (-10)$.

Solution : We know that the additive inverse of -10 is 10 .

Therefore, $(-8) - (-10) = -8 + (\text{additive inverse of } -10)$

$$= -8 + 10 = 2$$

Hence, $-8 - (-10) = 2$

Example 2. Subtract (-4) from (-10) .

Solution : $(-10) - (-4) = (-10) + (\text{additive inverse of } -4)$
 $= -10 + 4 = -6.$

Example 3. Subtract $(+3)$ from (-3) .

Solution : Here $(-3 - (+3)) = -3 + (\text{additive inverse of } +3)$
 $= -3 + (-3) = -6.$

Example 4 : Raisa and Fariha, two students of class six moved 6 steps to the right and 5 steps to the left from the centre point (Zero point) of the playground of their school to reach the position A and B. The right side is considered as positive direction.

- Write down the number with a sign that represents the position of A and B.
- Show the position of Raisa and Fariha on the number line.
- If Raisa and Fariha move one step ahead, do the addition of their position by using number line.

Solution :

a. Raisa moves 6 steps right from the zero position and Fariha moves 5 steps left from the zero position. Since the right side is positive, the left is negative.

So, the position of A = +6
 the position of B = -5

b.

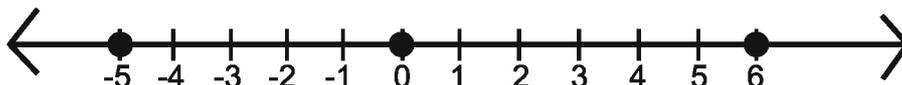

The position number of Raisa = +6

The position number of Fariha = -5

Raisa's position is +6, which is obtained by moving 6 steps right from zero on the number line. Again, Farihas position is -5, which is obtained by moving 5 steps to the left on the number line.

On the number line the round marked point on the right side of 0 = +6 and the round marked point on the left side of 0 = -5

(c) If Raisa moves one step further, the point obtained = $+6+1 = +7$

If Fariha moves one step further, the point obtained = $-5-1 = -6$

Now, the value of $+7+(-6)$ has to be determined by using number line.

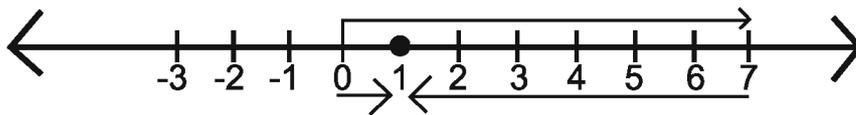

Let us cross 7 steps to the right from the zero point on the number line and reach point +7. Afterwards, crossing 6 steps to the left from the point (+7), let us reach the point (+1). It will be the sum of +7 and -6. $(+7)+(-6) = +1$ (figure)

Example 5 :

$$A = (-9) + 4 + (-6)$$

$$B = 7+(-4)$$

(a) determine the value of B.

(b) show that $A < B$

(c) Placing the value of A and B on the number line determine the value of $(A+B)$.

Solution :

$$\begin{aligned} \text{a. } B &= 7+(-4) \\ &= 7-4 \\ &= 3 \end{aligned}$$

b. From 'a', we get, $B = 3$

$$\begin{aligned} A &= (-9) + 4 + (-6) \\ &= -9+4-6 \\ &= -9-6+4 \\ &= -15+4 \end{aligned}$$

$$= -11$$

$$A = -11 \text{ and } B = 3$$

Now, it means the value of A is less than B.

$$\therefore A < B \text{ (Shown)}$$

c. From(b) we set, $A = -11$ and $B = 3$

$$A+B = -11(+3)$$

Now, using the number line, let us find out $(A+B)$.

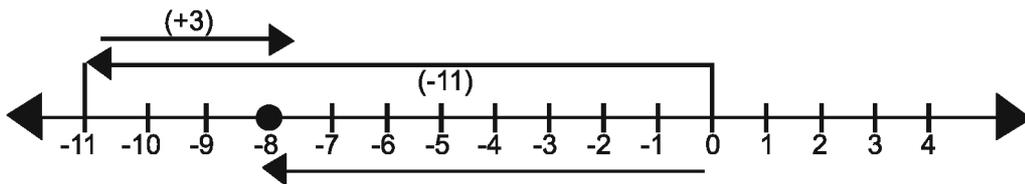

Crossing 11 steps to the left from 0 point on the number line let us reach the point (-11) . Then crossing 3 steps to the right of the point (-11) , let us reach the point (-8) . Therefore, the sum of -11 and 3 will be $-11+(+3) = -8$. So, $A+B = -8$

Exercise 3.3

- Which of the following is the additive inverse expression of $-a$?
 (a) $+a$ (b) $-a^2$ (c) $\frac{1}{a}$ (d) $-\frac{1}{a}$
- Which of the following is the sum of additive inverse number with 12 ?
 (a) -24 (b) -12 (c) 0 (d) 24
- $\square - 15 = -10$; what is the number in \square
 (a) -25 (b) -5 (c) 25 (d) 56 .

Answer questions 4 and 5 using the information below.

$-7, -8, -9$ three integers

- The sum of the additive inverse of the second number with the first number is-
 (a) -15 (b) -1 (c) 1 (d) 15

5. If the sum of the additive inverses of 1st and 3rd number is added to the 2nd number, it becomes A

(a) $A < -15$ (b) $A > -90$ (c) $A > 97$ (d) $A < -97$

6. If $A = 45 - (-11)$ and $B = 57 + (-4)$,

(i) $A = 56$ (ii) $B = -53$ (iii) $A - B = 3$;

Which one is correct?

(a) i and ii (b) i and iii (c) ii and iii (d) i, ii and iii

7.



In the marked place below

(i) Non negative integers (ii) all prime numbers

(iii) all even numbers

Which one is correct?

(a) i and ii (b) i and iii (c) ii and iii (d) i, ii and iii

Answer questions 8 and 9 using the following information.

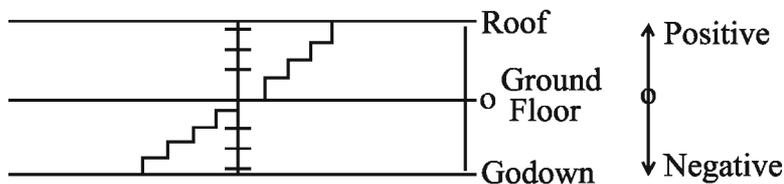

8. What type of number is the one that represents the ground floor?

(a) negative (b) non negative (c) odd (d) prime

9. Going up 3 stairs from the ground floor and then to move down 5 stairs from there-

(a) -8 (b) -2 (c) 2 (d) 8

10. Find the difference:

(a) $35 - 20$ (b) $72 - 90$ (c) $(-15) - (-18)$

(d) $(-20) - 13$ (e) $23 - (-12)$ (f) $(-32) - (-40)$

11. Fill in the blank with $>$, $<$ or $=$ sign.

(a) $(-3) + (-6) \square (-3) - (-6)$

(b) $(-21) - (-10) \square (-31) + (-11)$

(c) $45 - (-11) \square 57 + (-4)$

(d) $(-25) - (-42) \square (-42) - (-25)$

12. Fill in the blanks :

(a) $(-8) + \square = 0$

(b) $13 + \square = 10$

(c) $12 + (-12) = \square$

(d) $(-4) + \square = -12$

(e) $\square - 15 = -10$

13. Find the value of

(a) $(-7) - 8 - (-25)$

(b) $(-13) + 32 - 8 - 1$

(c) $(-7) + (-8) + (-90)$

(d) $50 - (-40) - (-2)$

14. -3, 6, 9 are three integers.

(a) Put the signs $>$, $<$ or $=$ in between -3 and 6 ;
9 and -3 ; $(-3 + 6)$ and $(9 - 6)$.

(b) Determine the value of $-(-3) + (-6) + 9$

(c) Using number line, determine the sum of -3 and 6 and
difference of 9 and 6.

Chapter Four

Algebraic Expressions

In Arithmetic, knowing about numbers and their characteristics we have solved different kinds of arithmetical problems. We have also learnt about shapes and sizes of objects in Geometry. Now we shall learn about Algebra, one of the most important branches of Mathematics. The important characteristics of this branch of Mathematics is the symbolic applications of alphabet. We can use symbolic alphabet for any number instead of a particular number. Secondly, since the alphabet is used for any unknown quantity and number, we can construct algebraic expression following mathematical operations. Algebraic symbols, variables, coefficients, indices, algebraic expressions, addition and subtraction of algebraic expressions have been presented in this chapter.

At the end of this chapter, the students will be able to

- solve Mathematical problems using algebraic symbol, variables, coefficient, index.
- identify the similar and dissimilar terms of algebraic expression.
- describe algebraic expression of one or more than one terms.
- do addition and subtraction of algebraic expressions.

4.1 Algebraic Symbols, Variables, Coefficients and Indices

The numerals or digits in arithmetic are 1, 2, 3, 4, 5, 6, 7, 8, 9, 0. The numerals or digits used in algebra are 1, 2, 3, 4, 5, 6, 7, 8, 9, 0. These numerals are used in writing any number. But the numerals as well as the alphabetical symbols are used in algebra. These are the fundamental characteristics of Algebra. The

alphabet $a, b, c, \dots p, q, r, \dots x, y, z$ etc. are used to express known or unknown numbers or expressions in algebra.

Let us suppose that Moli has got some mangoes. It is not said here exactly how many mangoes are there with Moli. She may have any number of mangoes. But, this can be expressed in algebra that she has x number of mangoes. If the numerical values of x is 5, then she has 5 mangoes ; if x is 10, then she has 10 mangoes etc.

Variable : The numerical values of letter x may be 5 or 10 or any number. These unknown expressions or alphabetical symbols are called variables in algebra. So, x is an examples of variable. Here x has been used as a variable. Why is not y a symbol instead of x ? The letter Y or any other symbol can be used instead of x .

Observe :

- * Variable is such a symbol of which meanig is changeable.
- * The value of variable is not fixed.
- * The variable can take different values.

Operational signs : Previously, in arithmetic we have learnt about addition, subtraction, multiplication and division. The signs used to express these operations are called operational signs.

Operational signs of Arithmetic	+	-	\times	\div
	Addition	Subtraction	Multiplication	Division
Operational signs of Algebra	+	-	\times, \cdot	\div
	Plus	Minus	Multiplication or dot	Division

Let, x and y be two variables. Then

x plus y is written as $x + y$

x minus y is written as $x - y$

x multiplication y is written as $x \times y$, or $x.y$, or xy

x division y is written as $x \div y$, or $\frac{x}{y}$

x multiplication 3 is written as, $x \times 3$ or , $x.3$ or $3x$; but it is not written as $x3$.

Usually, in case of a multiplication the numerical symbols are written first and then alphabetical symbols are written. Such as, $3x$, $5y$, $10a$ etc.

In Algebra a multiplication sign '×' is to be considered between two symbols written next to each other. For example, $a \times b = ab$, $a.b = ab$.

Example 1. What is meant by the following algebraic expressions ?

(i) $8x$ (ii) $a + 5b$ (iii) $3x - 2$ (iv) $\frac{ax + by}{4}$.

Solution :(i) $8x$ means $8 \times x$ or, $x \times 8$, that is the product of x and 8.

(ii) $a + 5b$ means 5 times of b is added with a .

(iii) $3x - 2$ means 2 is subtracted from the product of 3 and x .

(iv) $\frac{ax + by}{4}$ means sum of the product of a and x ; and the product of b and y is divided by 4.

Example 2. Write down the following by using the symbols +, −, ×, ÷ :

(i) Subtract three times of y from five times of x .

(ii) Add two times of c with the product of a and b .

(iii) Divide the sum of x and y and the difference of y from x .

(iv) Subtract four times of a number from five times of another number.

Solution : (i) 5 times of x is $5x$ and 3 times of y is $3y$.

$$\text{Required difference} = 5x - 3y.$$

(ii) The product of a and b is ab and two times of c is $2c$.

$$\text{Required addition} = ab + 2c.$$

- (iii) The sum of x and y is $x + y$
and the subtraction of y from x is $x - y$

$$\text{Required division} = \frac{x + y}{x - y}.$$

- (iv) Let a number be x , 5 times of x is $5x$
and another number is y , 4 times of y is $4y$
Required difference = $5x - 4y$

Activity :

1. What is meant by the following algebraic expressions?

(i) $7x$ (ii) $5 - 4x$ (iii) $8x + 9$ (iv) $\frac{2}{x} + \frac{3}{y}$

2. Write down the following by using the symbols $+$, $-$, \times , \div

- (i) Subtract five times of y from two times of x .
(ii) Add eight times of y with x .
(iii) Subtract three times of y from two times of x .
(iv) Subtract 4 from the product of x and 9.
(v) Add three times of a number with two times of another number.

4.2 Algebraic Expressions and Terms

$5x$, $2x + 3y$, $5x + 3y - z$, $3b \times c - y$, $5x \div 2y + 9x - y$, etc. are all algebraic expressions. The meaningful combination or arrangement of the numbers and the operational signs are called the algebraic expressions.

Each part of the algebraic expressions linked with the addition (+) and the subtraction (-) sign is known as a term of the expression. As for example, $4x + 3y$ is an expression. $4x$ and $3y$ are two terms in this expression. These are linked with addition sign. Again, $5x$, $3y \div c$, $4b \times 2y$ are three terms in the expression $5x + 3y \div c + 4b \times 2y$. $4x$ is a one term, $2x + 3y$ is a binomial, $a - 2b + 4c$ is a trinomial expression.

Activity: How many terms are there in the following expression and what are they ?

$$3a \div b + 8y - 2x \times 3c + 5z.$$

Coefficient : When a number is attached with a variable in a single term expression as a multiplier, that multiplier is called the numerical coefficient or coefficient of the expression. As for example, $3x$, $5y$, $8xy$, $9a$ etc. are single term expressions and 9 , 8 , 5 , 3 are the coefficient of x , y , xy and a respectively.

The number 1 is considered as coefficient of the expression, if there is no other number attached to a single term expression as a multiplier. As for example, a , b , y etc. are one term expressions and the coefficient of each of them is 1. Because, $a = 1a$ or $1 \times a$; $x = 1x$ or $1 \times x$.

When a letter-symbol is attached with variable as a multiplier, that multiplier is called the letter coefficient of the expression. As for example, in the expressions ax , by , mz etc. where $ax = a \times x$, $by = b \times y$, $mz = m \times z$; a , b and m respectively are called the letter coefficients of x , y and z . Again, in expression $3x + by$, the coefficients of x is 3 and the coefficient of y is b .

Example 3. Find the coefficient of :

(i) $8x$ (ii) $7xy$ (iii) $\frac{3}{2}ab$ (iv) axy (v) $-xyz$

Solution :

(i) $8x = 8 \times x$ \therefore the coefficient of x is 8.

(ii) $7xy = 7 \times xy$ \therefore the coefficient of xy is 7.

(iii) $\frac{3}{2}ab = \frac{3}{2} \times ab$ \therefore the coefficient of ab is $\frac{3}{2}$.

(iv) $axy = 1 \times axy$ \therefore the coefficient of axy is 1.

(v) $-xyz = -1 \times xyz \quad \therefore$ the coefficient of xyz is -1 .

Example 4. Find the letter coefficient of x :

(i) bx (ii) pqx (iii) $mx + c$ (iv) $ax - bz$.

Solution : (i) $bx = b \times x \quad \therefore$ the coefficient of x is b
 (ii) $pqx = pq \times x \quad \therefore$ the coefficient of x is pq
 (iii) $mx + c = m \times x + c \quad \therefore$ the coefficient of x is m
 (iv) $ax - bz = a \times x - bz \quad \therefore$ the coefficient of x is a

Example 5. If the price of a pen is Tk. x , the price of a notebook is Tk. y and the price of a clock is Tk. z ; what is meant by each of the following expressions ?

(i) $5x$ (ii) $7y$ (iii) $2x + 5y$ (iv) $x + y + z$ (v) $4x + 3z$

Solution : (i) $5x$ means the price of 5 pens.
 (ii) $7y$ means the price of 7 notebooks.
 (iii) $2x + 5y$ means the total price of 2 pens and 5 notebooks.
 (iv) $x + y + z$ means the total price of a pen, a notebook and a clock.
 (v) $4x + 3z$ means the total price of 4 pens and 3 clocks.

Example 6. If the price of a cow is Tk. x and the price of a goat is Tk. y ,

- (i) What is the total price of four cows and six goats ?
 (ii) What is the total price of seven cows and five goats ?

Solution : (i) Total price of four cows and six goats is Tk. $(4x + 6y)$.
 (ii) Total price of seven cows and five goats is Tk. $(7x + 5y)$.

Example 7 : Plabon bought 6 pens and 3 note books and Srabon bought 4 pens and 5 note books. The price of a pen is x taka and the price of a note book is y taka.

- Express the total cost of Plabon in algebraic terms.
- Determine the total cost of the two persons.
- If $x = 15$ and $y = 25$, determine the ratio of the cost of two persons.

Solution :

a. The price of 1 pen is x taka

So, the price of 6 pens is $6x$ taka

Again, the price of 1 note book is y taka

So, the price of 3 note books is $3y$ taka

So, the algebraic expression of Plabon's total cost is $6x+3y$

b. From 'a' we get the algebraic expression of the total cost of Plabon $6x+3y$. The price of 1 pen is x taka

So, the price of 4 pens is $4x$ taka.

Again, the cost of 1 note book is y taka

So, the cost of 5 note books is $5y$ taka

So, the algebraic expression of the total cost of Srabon is $4x+5y$

Placing similar terms one below another,

We get,

$$\begin{array}{r} 6x + 3y \\ (+) 4x + 5y \\ \hline 10x + 8y \end{array}$$

The total cost of the two persons is $(10x+8y)$ taka

c. $x = 15$ taka and $y = 25$ taka

The total cost of Plabon is $6x+3y$

$$= (6.15+3.25) \text{ taka}$$

$$= (90+75) \text{ taka}$$

$$= 165 \text{ taka}$$

The total cost of Srabon is $4x+5y$

$$= (4.15+5.25) \text{ taka}$$

$$= (60+125) \text{ taka}$$

$$= 185 \text{ taka}$$

The ratio of the cost of plabon and Srabon = $165: 185 = 33: 37$

Activity :

- Find the coefficient of : (a) $6x$ (b) $5xy$ (c) xyz (d) $-\frac{1}{2}y$.
- If the price of a notebook is Tk. x , the price of a pencil is Tk. y and the price of a rubber is Tk. z ,
 - What is the total price of three notebooks and five rubbers ?
 - What is the total price of four notebooks, two pencils and three rubbers ?
 - What is the total price of six notebooks and nine pencils ?
- Write down some algebraic expressions with numerical coefficients.

Exercise 4.1

- What is meant by the following algebraic expressions :

(i) $9x$ (ii) $5x + 3$ (iii) $3a + 4b$ (iv) $3a \times b \times 4c$

(v) $\frac{4x + 5y}{2}$ (vi) $\frac{7x - 3y}{4}$ (vii) $\frac{x}{3} + \frac{y}{2} - \frac{z}{5}$ (viii) $2x - 5y + 7z$

(ix) $\frac{2}{3}(x + y + z)$ (x) $\frac{ac - bx}{7}$

- Write down the following by using the symbols $+$, $-$, \times and \div :

- Add four times of x with five times of y .
- Subtract b from two times of a .
- Add three times of a number with two times of another number.

- (iv) Subtract three times of a number from four times of another number.
 (v) Divide the subtraction of b from a by the addition of a and b .
 (vi) Divide x by y and add 5 with the quotient.
 (vii) Divide 2 by x , 5 by y , 3 by z and add the quotients obtained.
 (viii) Divide a by b and add 3 with the quotient.
 (ix) Multiply p by q and add r with the product.
 (x) Multiply x by y and subtract 7 from the product.
3. How many terms are there in the expression $2x + 3y \div 4x - 5x \times 8y$ and what are the terms ?
4. Find out the number of terms in each of the following expressions:
 (i) $7xy$ (ii) $2a + b$ (iii) $x - 3y + 5z$
 (iv) $5a + 7b \times x - 3c \div y$ (v) $x + 5x \times b - 3y \div c$
5. (a) Find out the coefficient of every term :
 (i) $6b$ (iii) xy (ii) $7ab$ (iv) $2x + 5ab$
 (v) $2x + 8y$ (vi) $14y - 4z$ (vii) $-\frac{1}{2}xyz$
- (b) Find out the letter coefficient of x :
 (i) ax (ii) $ax + 3$ (iii) $ax + bz$ (iv) pxy
6. If the price of a pen is Tk. x and the price of a book is Tk. y , what is meant by each of the following expressions ?
 (i) $3y$ (ii) $7x$ (iii) $x + 9y$ (iv) $5x + 8y$ (v) $6y + 3x$
7. (a) If the price of a notebook is Tk. x , the price of a pencil is Tk. y and the price of a rubber is Tk. z ,
 (i) What is the total price of five notebooks and six pencils ?
 (ii) What is the total price of eight pencils and three rubbers ?

(iii) What is the total price of ten notebooks, five pencils and two rubbers ?

(b) If the price of a group of four bananas is Tk. x ,

(i) What is the price of 5 group of four bananas ?

(ii) What is the price of 12 bananas ?

8. Write down the correct answers :

(i) Which one of the following will be the result if 5 is subtracted from two times of x ?

(a) $2x + 5$

(b) $2x - 5$

(c) $\frac{x}{2} + 5$

(d) $5 - 2x$

(ii) Which one of the following will be the sum of 3 times of a with y times of x ?

(a) $3a + xy$

(b) $3x + ay$

(c) $ax + 3y$

(d) $ay + 3x$

(iii) Which one of the following will be the result if the product of b and x is subtracted from the product of a and c ?

(a) $ac + bx$

(b) $bc + ax$

(c) $ac - bx$

(d) $bx - ac$

4.3 Exponent

The prime factors of 2, 4, 8, 16 etc. are

$$2 = 2, 2 \text{ occurs one time} \quad = 2^1$$

$$4 = 2 \times 2 \text{ multiplication of 2 occurs twice} \quad = 2^2$$

$$8 = 2 \times 2 \times 2 \text{ multiplication of 2 occurs 3 times} \quad = 2^3$$

$$16 = 2 \times 2 \times 2 \times 2 \text{ multiplication of 2 occurs 4 times} \quad = 2^4$$

The number of times of factors occurring in a factor of any expression is called index and the factor is called base.

It is to be noted that as the factor 2 occurs once in 2, the number 1 is called index and 2 is its base. The factor 2 in 4 occurs 2 times. Hence, the index is 2 and its base is 2. Again, the factor 2 in 8 and 16 are 3 times and 4 times respectively. That is why, 3 is the index of 8 and its base is 2, and 4 is the index of 16 and its base is 2.

$8 = 2^3 \rightarrow \text{Index}$ \downarrow base

Power : a is an algebraic expression. If a is multiplied once, twice, thrice by a , it will be :

$a \times a = a^2$, where a^2 is the second power of a and it is read as square of a .

$a \times a \times a = a^3$, where a^3 is the 3rd power of a and it is read as cube of a .

$a \times a \times a \times a = a^4$, where a^4 is called the 4th power of a .

Similarly, if a is multiplied n times by a , then it will be $a \times a \times a \times \dots \times a$ (n times) $= a^n$. Here, a^n is called the n th power of a and n is the index and a is its base. So in the case of

a^2 , 2 is the index of power of a and its base is a ; in the case of a^3 , 3 is the index of power of a and its base is a etc.

In the case of numbers, the exponents when simplified give a result free of indices. But in the case of alphabet, the result will be in the form of index.

For example, $2^3 + 3^2 = 2 \times 2 \times 2 + 3 \times 3 = 8 + 9 = 17$

$$a^4 + 2^4 = a \times a \times a \times a + 2 \times 2 \times 2 \times 2 = a^4 + 16.$$

Example 8. Simplify :

$$(i) a \times a^2 \quad (ii) a^3 \times a^2 \quad (iii) a^4 \times a^3$$

Solution : (i) $a \times a^2 = a \times a \times a = a^3$

(ii) $a^3 \times a^2 = (a \times a \times a) \times (a \times a) = a \times a \times a \times a \times a = a^5$

(iii) $a^4 \times a^3 = (a \times a \times a \times a) \times (a \times a \times a) = a \times a \times a \times a \times a \times a \times a = a^7$

Observe : $a \times a^2 = a^1 \times a^2 = a^3 = a^{1+2}$

$$a^3 \times a^2 = a^5 = a^{3+2}$$

$$a^4 \times a^3 = a^7 = a^{4+3}, \text{ etc.}$$

So, we write $\boxed{a^m \times a^n = a^{m+n}}$, m and n natural numbers. This process of multiplication is called the multiplication rule of the indices.

If the power of any number is 1, the index 1 is usually omitted,
For example, $a = a^1$, $x = x^1$ etc.

Example 9. Multiply :

- (i) $a^4 \times a^5$
 (ii) $x^3 \times x^8$
 (iii) $x^5 \times x^9$

Solution : (i) $a^4 \times a^5 = a^{4+5} = a^9$

(ii) $x^3 \times x^8 = x^{3+8} = x^{11}$

(iii) $x^5 \times x^9 = x^{5+9} = x^{14}$

Example 10. Simplify : (i) $2a \times 3b^2 \times 4c \times 6a^2 \times 5b^3$
 (ii) $a \times a \times a \times b \times c \times b \times c \times a \times c \times b$.

Solution : (i) $2a \times 3b^2 \times 4c \times 6a^2 \times 5b^3$
 $= (2a \times 6a^2) \times (3b^2 \times 5b^3) \times 4c$
 $= (2 \times 6 \times a^{1+2}) \times (3 \times 5 \times b^{2+3}) \times 4c$
 $= 12a^3 \times 15b^5 \times 4c$
 $= (12 \times 15 \times 4) a^3 b^5 c$
 $= 720 a^3 b^5 c.$

(ii) $a \times a \times a \times b \times c \times b \times c \times a \times c \times b$
 $= (a \times a \times a \times a) \times (b \times b \times b) \times (c \times c \times c)$
 $= a^4 b^3 c^3.$

Example 11. If $a = 1$, $b = 2$, $c = 3$, find the value of the following expressions :

(i) $a^2 + b^2 + c^2$

(ii) $a^2 + 2ab - c.$

Solution : (i) $a^2 + b^2 + c^2$
 $= 1^2 + 2^2 + 3^2 = 1 + 2 \times 2 + 3 \times 3$
 $= 1 + 4 + 9 = 14.$

$$\begin{aligned}
 \text{(ii) } a^2 + 2ab - c & \\
 &= 1^2 + 2.1.2 - 3 = 1 + 4 - 3 \\
 &= 5 - 3 = 2.
 \end{aligned}$$

Activity : 1. Simplify : (i) $a \times a^3$ (ii) $a^3 \times a^5$ (iii) $a^9 \times a^6$
 2. If $a = 2$, find the value of $2a^3 \times 3a^2$.
 3. Write down the power, index and base of m times x (m is a natural number).

Exercise 4.2

1. Simplify :

$$\begin{array}{lll}
 \text{(i) } x^3 \times x^7 & \text{(ii) } a^3 \times a \times a^5 & \text{(iii) } x^4 \times x^2 \times x^9 \\
 \text{(iv) } m \times m^2 \times n^3 \times m^3 \times n^7 & & \text{(v) } 3a \times 4b \times 2a \times 5c \times 3b \\
 \text{(vi) } 2x^2 \times y^2 \times 2z^2 \times 3y^2 \times 4x^2 & &
 \end{array}$$

2. If $a = 2, b = 3, c = 1$, find the value of each of the following expressions :

$$\begin{array}{lll}
 \text{(i) } a^3 + b^2 & \text{(ii) } b^3 + c^3 & \text{(iii) } a^2 - b^2 + c^2 \\
 \text{(iv) } b^2 - 2ab + a^2 & & \text{(v) } a^2 - 2ac + c^2
 \end{array}$$

3. If $x = 3, y = 5, z = 2$, show that

$$\begin{array}{ll}
 \text{(i) } y^2 - x^2 = (x + y)(y - x) & \text{(ii) } (x + y)^2 = (x - y)^2 + 4xy \\
 \text{(iii) } (y + z)^2 = y^2 + 2yz + z^2 & \text{(iv) } (x + z)^2 = x^2 + 2xz + z^2
 \end{array}$$

4. Tick the correct answers :

$$\begin{array}{ll}
 \text{(i) Which one is the value of } a^7 \times a^8 ? & \\
 \text{(a) } a^{56} & \text{(b) } a^{15} \quad \text{(c) } 15 \quad \text{(d) } 56 \\
 \text{(ii) Which one is the value of } a^3 \times a^{-3} ? & \\
 \text{(a) } a^6 & \text{(b) } a^9 \quad \text{(c) } a^0 \quad \text{(d) } a^3
 \end{array}$$

- (iii) Which one is the value of $5x^2 \times 4x^4$?
 (a) x^6 (b) $20x^6$ (c) $20x^8$ (d) $9x^6$
- (iv) Which one is the index of x in $x^5 \times x^4$?
 (a) x^{20} (b) x^9 (c) 9 (d) 20
- (v) Which one is the index of a in $5a^3 \times a^5$?
 (a) 5 (b) a^8 (c) 15 (d) 8

4.4 Similar and dissimilar terms

$7a^2bx$, $8a^2bx$ are two algebraic expressions. The difference between two terms of expressions is only in their numerical coefficients. These two terms are similar terms.

Two terms are called similar, if they differ only in their numerical coefficients. Otherwise, the terms are called dissimilar. For Example, the numerical coefficient of two expressions $9ax$ and $9ay$ is the same, but two terms are different, so they are dissimilar.

Similar and dissimilar terms can be observed in the following examples :

Similar terms : (i) $5a$, $6a$ (ii) $3a^2$, $5a^2$ (iii) $5abx$, $8xab$
 (iv) $2x^2ab$, $-x^2ab$ (v) $3x^2yz$, $5yx^2z$, $7yzx^2$

Dissimilar terms : (i) $3xy^2$, $3x^2y$ (ii) $5abx$, $5aby$
 (iii) ax^2y^2 , bx^2y^2z , cxy^2 (iv) ax^3yz , bxy^2z , $cxyz$

Observe : Though the algebraic symbols of more than one term are the same and their numerical coefficients are equal, they may be dissimilar. Such as, $3ax^2$ and $3x^2a$ are similar terms, but $5ab^2$ and $5a^2b$ are dissimilar terms.

4.5 Addition of the algebraic expressions

For addition of two or more algebraic expressions, the coefficients of the similar terms are to be added by the rule of addition of signed numbers, then the symbols are to be placed next to the coefficient obtained. Dissimilar terms with their signs are to be placed in the total.

Example 12 (a). Add :
 $2a + 4b + 5c, 3a + 2b - 6c$.

Solution:

$$\begin{aligned} & (2a + 4b + 5c) + (3a + 2b - 6c) \\ &= (2a + 3a) + (4b + 2b) + (5c - 6c) \\ &= 5a + 6b - c. \end{aligned}$$

The required sum is $5a + 6b - c$.

Alternative method : First write the similar terms with their signs, one below the other,

Now we get,

$$\begin{array}{r} 2a + 4b + 5c \\ + 3a + 2b - 6c \\ \hline 5a + 6b - c \end{array}$$

The required sum is $5a + 6b - c$.

Example 12 (b). Add :
 $3a + 6b + c, 5a + 2b + d$.

Solution :

$$\begin{aligned} & (3a + 6b + c) + (5a + 2b + d) \\ &= (3a + 5a) + (6b + 2b) + c + d \\ &= 8a + 8b + c + d. \end{aligned}$$

[Here, by adding the similar terms that have been added with the sum of dissimilar terms]

The required sum is

$$8a + 8b + c + d.$$

Observe : The algebraic sum of the numerical coefficients of the similar terms have been determined. Algebraic symbols are to be placed next to the obtained sum. Then the sum of all terms obtained is the required sum.

Example 13. Add : $5a + 3b - c^2, -3a + 4b + 4c^2, a - 8b + 2c^2$.

Solution : Arranging the similar terms one below the other, we get,

$$\begin{array}{r} 5a + 3b - c^2 \\ - 3a + 4b + 4c^2 \\ \hline a - 8b + 2c^2 \\ \hline 3a - b + 5c^2. \end{array}$$

The required sum is $3a - b + 5c^2$.

Example 14. Add :

(i) $7x - 5y + 7z, 2x - 3z + 7y, 8x + 2y - 3z$.

(ii) $4x^2 - 3y + 7z, 8x^2 + 5y - 3z, y + 2z$.

<p>Solution : (i) $\begin{array}{r} 7x - 5y + 7z \\ 2x + 7y - 3z \\ 8x + 2y - 3z \\ \hline 17x + 4y + z \end{array}$</p>	<p>(ii) $\begin{array}{r} 4x^2 - 3y + 7z \\ 8x^2 + 5y - 3z \\ \quad + y + 2z \\ \hline 12x^2 + 3y + 6z \end{array}$</p>
--	--

The required sum is $17x + 4y + z$ The required sum is $12x^2 + 3y + 6z$

Observe : If there is no sign before any expressions, it is supposed that there is the plus (+) sign.

Activity :

1. Make some algebraic expressions of similar and dissimilar terms.
2. Add :
 - (i) $a + 4b - c, 7a - 5b + 4c.$
 - (ii) $3x + 7y + 4z, y + 4z, 9x + 3y + 6z.$
 - (iii) $2x^2 + y^2 - 8z^2, -x^2 + y^2 + z^2, 4x^2 - y^2 + 4z^2.$
3. Make three similar and dissimilar algebraic expressions consisting of addition and subtraction sign and find out the sum of them.

4.6 Subtraction of algebraic expressions

$$a - b = a + (-b)$$

For subtraction the expression obtained by changing the sign of each term of the subtraction is to be added to the first expression.

Example 15. Subtract $3a - 4b - 6c$ from $5a + 4b - 5c$.

Solution : Changing the sign of each term of $3a - 4b - 6c$, the subtracting expression becomes $-3a + 4b + 6c$.

Now, we add the changed subtracting expression to $5a + 4b - 5c$. Then we get,

$$\begin{array}{r} 5a + 4b - 5c \\ -3a + 4b + 6c \\ \hline 2a + 8b + c \end{array}$$

Alternative methods :

$$\begin{array}{r} 5a + 4b - 5c \\ 3a - 4b - 6c \\ \hline (-) \quad (+) \quad (+) \\ 2a + 8b + c \end{array}$$

The required difference is $2a + 8b + c$ | Here, changing the sign of each term of the subtraction.

Example 16. Subtract $-3xy^2 - 4x^2y + 5x^2$ from $5x^2 - 4x^2y + 5xy^2$.

Solution : Changing the sign of each term of subtracting expression, we get

$$3xy^2 + 4x^2y - 5x^2$$

Now, adding this changed subtracting expression to the first expression, we get,

$$\begin{array}{r} 5x^2 - 4x^2y + 5xy^2 \\ -5x^2 + 4x^2y + 3xy^2 \\ \hline 0 + 0 + 8xy^2 \end{array}$$

The required difference is $8xy^2$.

Example 17. Subtract :

(i) $3xy - yz + 2zx$ from $4xy + 2yz + 5zx$

(ii) $2ab - 2bc - 5ca - 6$ from $3ab + bc - 4ca - 5$

Solution : (i)
$$\begin{array}{r} 4xy + 2yz + 5zx \\ 3xy - yz + 2zx \\ (-) \quad (+) \quad (-) \\ \hline xy + 3yz + 3zx \end{array}$$

The required difference is $xy + 3yz + 3zx$.

(ii)
$$\begin{array}{r} 3ab + bc - 4ca - 5 \\ 2ab - 2bc - 5ca - 6 \\ (-) \quad (+) \quad (+) \quad (+) \\ \hline ab + 3bc + ca + 1 \end{array}$$

The required difference is $ab + 3bc + ca + 1$

Observe : After writing the first expression, changing the sign of terms of the second expression, it is added by placing the similar terms one below the other.

Example 18 : p, q, r are three algebraic expressions, in which,

$p = 7a + 5b + 6c$, $q = 3a - b + 9c$ and $r = -3c + 6b + 4a$

a. If $a = 1$, $b = 2$ and $c = 3$, find the value of q .

b. determine $2p - 3q - 5r$

- c. Prove that the sum of the given expressions is equal to twice the first expression.

Solution :

$$\begin{aligned} \text{a. } q &= 3a-b+9c \\ &= 3.1-2+9.3 \text{ (putting the value)} \\ &= 3-2+27 \\ &= 30-2 \\ &= 28 \end{aligned}$$

$$\begin{aligned} \text{b. } 2p - 3q + 5r &= 2(7a+5b+6c) - 3(3a-b+9c) + 5(-3c+6b+4a) \text{ [putting value]} \\ &= 14a+10b+12c - 9a+3b-27c-15c+30b+20a \\ &= 14a+20a-9a+10b+3b+12c-27c-15c \\ &= 25a+43b-30c \end{aligned}$$

- c. Arranging the similar terms one below the other,

We get,

$$\begin{array}{r} 7a+5b+6c \\ 3a-b+9c \\ (+) \underline{4a+6b-3c} \\ 14a+10b+12c \end{array}$$

The sum of the expression = $14a+10b+12c$

$$= 2(7a+5b+6c) = 2 \times \text{the first expression}$$

The sum of the expressions is equal to twice the first expression (proved)

Activity : Subtract :

(i) $-4b+3a-4c$ from $8a-4b+6c$.

(ii) x^3-4x^2+3x-2 from $2x^3-4x^2+3x+1$.

(iii) $-2x^2+4x^2y-3xy^2+2y^2$ from $x^2+3xy^2+3x^2y+y^2$.

2. Make three algebraic expressions having similar and dissimilar terms by using plus (+) and minus (-) sign and subtract one from the other.

Exercise 4.3

- Which one of the following is the coefficient of x in $5x + 3y$?
 (a) 8 (b) $5x$ (c) $3y$ (d) 5
- Which one of the following is the sum of three times of x and two times of y ?
 (a) $y + 3x$ (b) $3x + 2y$ (c) $x + 2y$ (d) $2x + 3y$
- Which one is the index of x in $7x^3 \times x^2$?
 (a) 7 (b) 5 (c) x^5 (d) x^6
- Which of the following indicates a pair of similar terms?
 (a) $2x, -7xy$ (b) $-3xy, 7x^2y$ (c) $3x^2, -7x^2$ (d) $-7x^2y, 8xy^2$
- If $m = -6$ in expression $m^2 - 7$, what is the value of the expression ?
 (a) 36 (b) 13 (c) -29 (d) 29
- If you Subtract $b - a$ from $a - b$, what is difference ?
 (a) $a + b$ (b) 0 (c) $2a - 2b$ (d) a
- What is the sum of three expressions $x^2 + 3, x^2 - 2, -2x^2 + 1$?
 (a) 1 (b) 2 (c) $x^2 - 1$ (d) $1 - x^2$
- In the expression $5x^4$
 (a) The power of x is 4 (b) two terms are there
 (c) The co-efficient of x^4 is 5.
 Which one is correct?
 (a) i and ii (b) i and iii (c) ii and iii (d) i, ii and iii
- In x and y variables-
 (i) The sum is $x + y$
 (ii) The product is xy
 (iii) The summation of square is $x^2 - y^2$
 Which one is correct?
 (a) i and ii (b) i and iii (c) ii and iii (d) i, ii and iii
 $x^2 - y^2, y^2 - z^2$ and $z^2 - x^2$ are three algebraic expressions.

Answer questions 10-11 using the information.

10. If $x = 2$ and $y = -3$, what is the value of the first expression?
 (a) -13 (b) -5 (c) 5 (d) 13
11. What is the sum of the three expressions?
 (a) 0 (b) $2x^2$ (c) $2x^2+2y^2+2z^2$ (d) $-2x^2-2y^2-2z^2$
12. (i) $12x$ is the sum of x and the power of 12
 (ii) The index of a is 3 in expression $4a^3$.

(iii) The coefficient of x in the expression $3x + 4$ is 3.

Which one is correct on the basis of above information ?

- (a) i & ii (b) i & iii (c) ii & iii (d) i, ii & iii
13. (i) Two terms $5ax^2$ and $-7x^2a$ are similar.
 (ii) There are 4 terms in the algebraic expression $3x^2 + 2x \div y - 5x$.
 (iii) If $a = 2$ and $b = 3$, the value of $4a - b$ will be 5.
 Which one is correct on the basis of above information ?
 (a) i & ii (b) ii & iii (c) i & iii (d) i, ii & iii

14. $9x^2, 8x^2, 5y^2$ are three algebraic expressions. Then -

- (1) What is the sum of the numerical coefficients of three expressions ?
 (a) 13 (b) 14 (c) 17 (d) 22
- (2) What is the index of the product of the first two expressions ?
 (a) 72 (b) 17 (c) 4 (d) 0

15. $x^2 + y^2 + z^2, x^2 - y^2 + z^2, -x^2 + y^2 - z^2$ are three algebraic expressions. On the basis of this information, answer the following questions (1) to (4) :

(1) Which one will be the sum of difference of the first two expressions with the third expression ?

- (a) $-x^2 + 3y^2 - z^2$ (b) $3x^2 - y^2 + 3z^2$ (c) $x^2 - 3y^2 + z^2$ (d) $x^2 + y^2 + z^2$

(2) What is the coefficient of y^2 in the second expression ?

- (a) 0 (b) -1 (c) 1 (d) 2

- (3) What is the sum of the three expressions ?
 (a) $3x^2 + y^2 + z^2$ (b) $2x^2 + y^2 + z^2$ (c) $x^2 + y^2 + z^2$ (d) $x^2 - y^2 + z^2$
- (4) Which one will be the difference of the third expression from the sum of the first two expressions ?
 (a) $3x^2 + 2y^2 - z^2$ (b) $3x^2 - y^2 + 3z^2$
 (c) $x^2 + 2y^2 - 2z^2$ (d) $3x^2 + 3y^2 + 3z^2$

Add (16 – 25) :

16. $3a + 4b, a + 3b$
 17. $2a + 3b, 3a + 5b, 5a + 6b.$
 18. $4a - 3b, -3a + b, 2a + 3b.$
 19. $7x + 5y + 2z, 3x - 6y + 7z, -9x + 4y + z.$
 20. $x^2 + xy + z, 3x^2 - 2xy + 3z, 2x^2 + 7xy - 2z.$
 21. $4p^2 + 7q^2 + 4r^2, p^2 + 3r^2, 8q^2 - 7p^2 - r^2.$
 22. $3a + 2b - 6c, -5b + 4a + 3c, 8b - 6a + 4c.$
 23. $2x^3 - 9x^2 + 11x + 5, -x^3 + 7x^2 - 8x - 3, -x^3 + 2x^2 - 4x + 1.$
 24. $5ax + 3by - 14cz, -11by - 7ax - 9cz, 3ax + 6by - 8cz.$
 25. $x^2 - 5x + 6, x^2 + 3x - 2, -x^2 + x + 1, -x^2 + 6x - 5.$
 26. If $a^2 = x^2 + y^2 - z^2, b^2 = y^2 + z^2 - x^2, c^2 = x^2 + z^2 - y^2$, then show that, $a^2 + b^2 + c^2 = x^2 + y^2 + z^2.$
 27. If $x = 5a + 7b + 9c, y = b - 3a - 4c, z = c - 2b + a$, then show that, $x + y + z = 3(a + 2b + 2c).$

Subtract (28 – 35) :

28. $5a + 4b - 2c$ from $3a + 2b + c$
 29. $2ab - 4bc + 8ca$ from $3ab + 6bc - 2ca$
 30. $-a^2 + b^2 - c^2$ from $a^2 + b^2 + c^2$
 31. $6by + 3ax + 9cz$ from $4ax + 5by + 6cz$
 32. $5x + 9 + 8x^2$ from $7x^2 + 9x + 18$
 33. $-x^3y^2 + x^2y^2 + 5xy + 2$ from $3x^3y^2 - 5x^2y^2 + 7xy + 2$

34. $-2y^2 + 3x^2 - z$ from $4x^2 + 3y^2 + z$
35. $x^3 - 2x^2 + 2x + 3$ from $x^4 + 2x^3 + x^2 + 4$
36. If $a = x^2 + z^2$, $b = y^2 + z^2$, $c = x^2 + y^2$, show that, $a + b - c = 2z^2$.
37. If $x = a + b$, $y = b + c$, $z = c + a$, show that, $x - y + z = 2a$
38. If $x = a + b + c$, $y = a - b - c$, $z = b - c + a$, show that,
 $x - y + z = a + 3b + c$.
39. If a^2 , b^2 , c^2 are three algebraic expressions,
(a) What is the numerical coefficient of b^2 ?
(b) Add three times of c^2 with the difference of two times of a^2 .
(c) Add four times of c^2 with the difference of two times of b^2 from three times of a^2 .
40. If the price of a notebook is Tk. x , the price of a pen is Tk. y and the price of a pencil is Tk. z ,
(a) What is the total price of 3 notebooks and 2 pens?
(b) What will be the price of 10 pens deducted from the total price of 5 notebooks and 8 pencils? Express it in the algebraic expression.
(c) What is meant by $3x - 2y + 5z$? What are the numerical coefficients of y and z ? What is the product of numerical coefficient of x , y and z ?
41. If $5x^2 + xy + 3y^2$, $x^2 - 8xy$, $y^2 - x^2 + 10xy$ are three algebraic expressions,
(a) How many terms are there in the first expression and what are they?
(b) Add three expressions. What is the coefficient of xy in the sum?
(c) Simplify $(5x^2 + xy + 3y^2) - (x^2 - 8xy) - (y^2 - x^2 + 10xy)$ and find out the value, when $x = 2$ and $y = 1$.
42. $x = (a+b)^2$, $y = a^2 + 2ab + b^2$ and $z = a^2 + b^2 - 2ab$
(a) determine the sum of the numerical co-efficients of z terms.
(b) determine $y+z$ and $y-z$
(c) If $a = 3$ and $b = -2$, prove that $x = y$

Chapter Five

Simple Equations

In the fourth chapter, we have got the idea about the algebraic symbols and variables; also, we have known how to form algebraic expressions with the help of the algebraic symbols and variables. In this chapter, we shall learn how to form equations by using algebraic expressions. Equations play an important role in solving mathematical problems. Students must have the knowledge about the formation of equations and their solutions. In this chapter, topics related to equations have been presented.

At the end of this chapter, students will be able to

- explain what equation is.
- explain and solve the simple equations.
- form equation related to real life problems and solve them.

5.1 Equation

A shopkeeper puts a weight of 5 kg on the left scale-pan of a scale of balance and some potatoes on the right scale-pan. Have the weights on the two scale-pans become equal ?

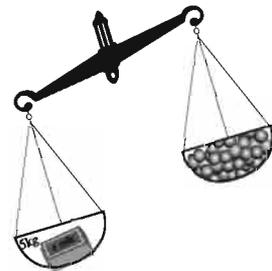

Now the shopkeeper puts a weight of 1 kg with the potatoes on the right scale-pan. Then the weights of the things on two scale-pans have become equal. If the unknown weight of potatoes is supposed to be x kg, the total weight of the things together with the weight of weighing metal on the right scale-pan will be $(x+1)$ kg. Therefore, we can write, $x+1 = 5$. This is an equation.

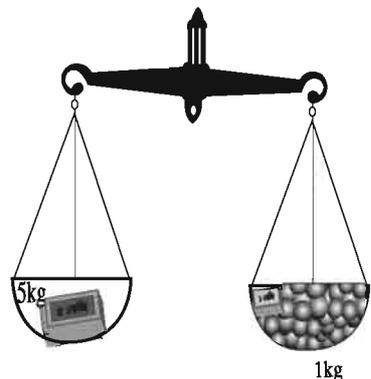

$x + 1 = 5$ is a mathematical open sentence as well as an equality. A mathematical open sentence associated with equality sign is called an equation. Here the unknown quantity is called variable. Mainly the small letters x, y, z of English alphabet are used as variables.

Therefore, we can say that a mathematical sentence associated with an unknown quantity or variable, operational sign and equality sign is the equation.

An equation has two sides. The expression on the left of equality sign ($=$) is called left side and the expression on the right of the equality sign is called the right side.

Activity :

Each of you write down five equations involving y and five equations involving z .

5.2 Simple Equations

Equations having variables of degree 1 is called a simple equation. $x + 1 = 5$, $2x - 1 = 3$, $2y + 3 = y - 5$, $2z - 1 = 0$, all these are equations having one variable of degree 1, or simple equations.

$x + y = 3$, $2x = y - 5$, are simple equations with two variables. In this chapter, we shall discuss the simple equations with one variable only.

5.3 Solution to simple equations

The process of determining the value of the variable from an equation is called the solution to the equation. The value of the variable is called the root of the equation. The equation will be satisfied by its root. That is, the two sides of the equation become equal. In the solution, variable is usually kept on left hand side.

Following axioms are used in solving equations. The letters a, b, c used in the following examples of the axioms may be any positive or negative integer or any fraction.

- (1) If the same quantity is added to each of equal quantities, their sum will also be equal to one another.
Such as, if $a = b$, $a + c = b + c$; here c is added to both sides.
- (2) If the same quantity is subtracted from each of equal quantities, their difference will also be equal to one another.
Such as, if $a = b$, $a - c = b - c$; here c is subtracted from both sides.
- (3) If each of equal quantities is multiplied by the same quantity, their product will also be equal to one another.
Such as, if $a = b$, $ac = bc$; here both sides are multiplied by c .
- (4) If each of equal quantities are divided by the same non-zero quantity, their quotient will also be equal to one another.
Such as, if $a = b$, $\frac{a}{c} = \frac{b}{c}$; here both sides are divided by c , $c \neq 0$.

The above mentioned axioms are mostly used for simplification in solving equations.

For example, we shall determine the value of x by solving the equation $2x - 1 = 5$. Here, it is necessary to keep x only on the left side. So, first we are to remove -1 from the left side. Then we are to make the coefficient of x equal to 1. That is, to remove the coefficient 2 of x .

Now, for the first case, 1 is to be added to -1 . But no quantity can be added to one side only; it is to be added to both sides. Otherwise, both sides do not become equal.

$$\begin{aligned} \therefore & \text{ We add 1 to both sides of the equation } 2x - 1 = 5 \\ \therefore & 2x - 1 + 1 = 5 + 1 \quad \text{or} \quad 2x = 6. \end{aligned}$$

Now, to remove the coefficient 2 of x from the left side, we are to divide both sides by 2.

$$\begin{aligned} \therefore & \text{ We write, } \frac{2x}{2} = \frac{6}{2} \\ & \text{or } x = 3. \end{aligned}$$

\therefore by solving the equation $2x - 1 = 5$, we get 3 as the value of x . But we are to verify, whether the solution is correct or not. It is the verification of correctness of the solution.

For this, we are to put the value of x in the given equation.

Left side = $2x - 1 = 2 \times 3 - 1 = 6 - 1 = 5 =$ Right side.

\therefore the solution is correct.

If the variable remains in both sides, the value of the variable is to be put on both sides separately.

Activity : Each of you write down an example for each of the four axioms and simplify.

Example 1. Solve and verify the correctness of the solution : $x + 1 = 5$

Solution : $x + 1 = 5$

or, $x + 1 - 1 = 5 - 1$ [Subtracting 1 from both sides]

or, $x = 4$

\therefore solution : $x = 4$

To verify the correctness of the solution : Putting $x + 1 = 5$ in the given equation, left side = $x + 1 = 4 + 1 = 5 =$ right side

\therefore the solution is correct.

Example 2. Find the root of the equation : $x - 3 = 7$.

Solution : $x - 3 = 7$

or, $x - 3 + 3 = 7 + 3$ [Adding 3 on both sides]

or, $x = 10$

\therefore The root of the given equation is 10.

Example 3. Solve : $2z + 5 = 15$.

Solution : $2z + 5 = 15$

or, $2z + 5 - 5 = 15 - 5$ [Subtracting 5 from both sides]

or, $2z = 10$

or, $\frac{2z}{2} = \frac{10}{2}$ [Dividing both sides by 2]

$$\text{or, } z = 5$$

$$\therefore \text{ solution : } z = 5$$

Example 4. Solve : $5 - x = 7$.

Solution : $5 - x = 7$

$$\text{or, } 5 - x - 5 = 7 - 5 \text{ [subtracting 5 from both sides]}$$

$$\text{or, } -x = 2$$

$$\text{or, } (-x) \times (-1) = 2 \times (-1) \text{ [multiplying both sides by } (-1)\text{]}$$

$$\text{or, } x = -2$$

$$\therefore \text{ solution : } x = -2.$$

Example 5. Find the root of the following equation and verify the correctness of the solution : $5y - 2 = 3y + 8$.

Solution : $5y - 2 = 3y + 8$

$$\text{or, } 5y - 2 + 2 = 3y + 8 + 2 \text{ [adding 2 on both sides]}$$

$$\text{or, } 5y = 3y + 10$$

$$\text{or, } 5y - 3y = 3y + 10 - 3y \text{ [subtracting } 3y \text{ form both sides]}$$

$$\text{or, } 2y = 10$$

$$\text{or, } \frac{2y}{2} = \frac{10}{2} \text{ [dividing both sides by 2]}$$

$$\text{or, } y = 5$$

\therefore The root of the given equation is 5.

Verification of the solution :

Putting $y = 5$ in given equation,

$$\text{left side} = 5y - 2 = 5 \times 5 - 2 = 25 - 2 = 23$$

$$\text{right side} = 3y + 8 = 3 \times 5 + 8 = 15 + 8 = 23$$

\therefore the solution to the equation is correct.

Activity :

1. Solution of the equation $2x + 5 = 9$ is $x = 2$. Verify the correctness of the solution.
2. Solve the equation $3x - 8 = x + 2$ and verify the correctness of the solution.

5.4 Formation of equations related to real life problems and its solutions:

You had some chocolates. Out of them you gave your sister Rita 3 chocolates. 7 more chocolates are left with you. Can you say, how many chocolates you had at first ?

It is unknown, how many chocolates you had at first. Let us suppose, you had at first x chocolates. Then after giving your sister Rita 3 chocolates, your chocolates will be less by 3. So, you will have then $(x - 3)$ chocolates. But by the question, you still have 7 chocolates left. Therefore, we can write,

$$x - 3 = 7$$

$$\text{or, } x - 3 + 3 = 7 + 3 \quad [\text{adding 3 on both sides}]$$

$$\text{or, } x = 10$$

\therefore You had 10 chocolates in total.

Here, the formed equation is $x - 3 = 7$
and its solution is $x = 10$.

Activity :

The breadth of a rectangular garden is less than its length by 3 meters. Each of you write down the length and the breadth of the garden in terms of x .

Example 6 . If 5 is added to twice a number, the sum will be 17. What is the number ?

Solution : Let us suppose that the number is x . Its twice is $2x$. If 5 is added to it, the sum will be $2x + 5$

By the question, $2x + 5 = 17$

$$\therefore 2x + 5 = 17$$

$$\text{or, } 2x + 5 - 5 = 17 - 5 \quad [\text{subtracting 5 from both sides}]$$

$$\text{or, } 2x = 12$$

$$\text{or, } \frac{2x}{2} = \frac{12}{2} \quad [\text{dividing both sides by 2}]$$

$$\text{or, } x = 6$$

\therefore the number is 6

Example 7. The sum of two consecutive odd natural numbers is 16. Find the numbers.

Solution : Let the first odd natural number be x . Then the second natural number will be $x + 2$.

According to the question,

$$x + x + 2 = 16$$

$$\text{or, } 2x + 2 = 16$$

$$\text{or, } 2x + 2 - 2 = 16 - 2 \quad [\text{subtracting 2 from both sides}]$$

$$\text{or, } 2x = 14$$

$$\text{or, } \frac{2x}{2} = \frac{14}{2} \quad [\text{dividing both sides by 2}]$$

$$\text{or, } x = 7$$

\therefore The first odd number is 7 and the second odd number is $x + 2 = 7 + 2 = 9$.

\therefore the numbers are 7, 9

Activity :

Make a problem similar to the example 7 and solve it.

Example 8. What is to be added to the antecedent of the ratio $2 : 3$, so that the ratio will be $5 : 1$?

Solution : Let, x is to be added to the antecedent of the ratio $2 : 3$. Then the ratio will be $(2 + x) : 3$.

By the question, $\frac{2 + x}{3} = \frac{5}{1}$

$$\text{or, } \frac{2 + x}{3} \times 3 = \frac{5}{1} \times 3 \quad [\text{Multiplying both sides by 3}]$$

$$\text{or, } 2 + x = 15$$

$$\text{or, } 2 + x - 2 = 15 - 2 \quad [\text{subtracting } 2 \text{ from both sides}]$$

$$\text{or, } x = 13$$

\therefore 13 is to be added with the antecedent.

Example 9. Mina had 12 marbles. Out of them she gave some marbles to her friend Kanak Chakma. Then 7 more marbles were left with her. How many marbles did Mira give Kanak ?

Solution : Let Mira gave x marbles to her friend Kanak. Then $(12 - x)$ marbles were left with her. But by the question, 7 marbles were left with her.

$$\therefore 12 - x = 7$$

$$\text{or, } 12 - x - 12 = 7 - 12 \quad [\text{subtracting } 12 \text{ from both sides}]$$

$$\text{or, } -x = -5$$

$$\text{or, } (-1) \times (-x) = (-1) \times (-5) \quad [\text{multiplying both sides by } (-1)]$$

$$\text{or, } x = 5$$

\therefore Mira gave Kanak Chakma 5 marbles.

Activity :

1. Make a problem similar to the example 9 and solve it.

Example 10. Sihab bought 6 pens from a shop and gave a note of 50 taka to the shopkeeper. The shopkeeper returned 20 taka. Sihab bought 3 exercise books each costing y taka from another shop. Then,

- a. Form an equation by supposing each pen costing x taka.
- b. Find the cost of each pen.
- c. If the cost of 3 exercise books be equal to the cost of 6 pens, what does each exercise book cost ?

Solution :

- a. If the cost of each pen is x taka, the cost of 6 pens will be $6 \times x$ taka = $6x$ taka. But by the question, the total cost of 6 pens = $(50 - 20)$ taka = 30 taka.

$$\therefore 6x = 30$$

b. $6x = 30$

or, $\frac{6x}{6} = \frac{30}{6}$ [dividing both sides by 6]

or, $x = 5$

\therefore each pen costs 5 taka.

c. The cost for 3 exercise books = $(3 \times y)$ taka = $3y$ taka.

Again, the cost of 6 pens = (6×5) taka = 30 taka

By the question, $3y = 30$

or, $\frac{3y}{3} = \frac{30}{3}$ [dividing both sides by 3]

or, $y = 10$

\therefore each khata costs 10 taka.

Activity :

Make a problem similar to the example 10 and solve it.

Example 11 If 5 is subtracted from the four times of a number, the obtained subtraction will be 19 more than twice the number.

- If the number is x , make an equation in the light of the information.
- Determine the number.
- If the number is the sum of three consecutive natural numbers, determine the smallest number.

Solution :

- a. Suppose the number is x

If 5 is subtracted from the four times of the number, the subtraction will be $4x-5$ and

if 19 is added to twice the number, the sum will be $2x+19$
according to the question, $4x-5 = 2x+19$

- b. From 'a' we get, $4x-5 = 2x+19$
 Or, $4x-5+5 = 2x+19+5$ [adding 5 to both the sides]
 Or, $4x = 2x+24$
 Or, $4x-2x = 2x+24-2x$ [Subtracting $2x$ from both the sides]
 Or, $2x = 24$
 Or, $\frac{2x}{2} = \frac{24}{2}$ [dividing both sides by 2]
 Or, $x = 12$
 So, the number is 12.
- c. From 'b' we get the number 12
 Suppose, The 1st consecutive number be y
 The 2nd consecutive number will be $y+1$
 The 3rd consecutive number will be $y+2$

According to the condition,

$$y + (y+1) + (y+2) = 12$$

Or, $y+y+1+y+2 = 12$
 Or, $3y+3 = 12$
 Or, $3y+3-3 = 12-3$ [Subtracting 3 from both the sides]
 Or, $3y = 9$
 Or, $\frac{3y}{3} = \frac{9}{3}$ (dividing both sides by 3)
 Or, $y = 3$
 So, the smallest number will be 3.

Exercise 5

- Which one of the following is the value of the variable in the equation $x+3=8$?
 a. 3 b. 5 c. 8 d. 11
- Which one of the following is the root of the equation $4x=8$?
 a. 2 b. 4 c. 8 d. 32
- Amount of Mack's money is twice the amount of Marrie's money. They have together 30 taka in total. How much money does Marrie have?
 a. 30 b. 20 c. 15 d. 10

4. What is the perimeter of a rectangular garden having length of x metre and breadth of y metre?
(a) $x-y$ (b) $2(x-y)$ (c) $x+y$ (d) $2(x+y)$
5. Find out the value of x when 3 is added to twice x that gives a sum of 9.
(a) 3 (b) 4 (c) 6 (d) 8
6. In the equation $6x+3 = 9$
(i) variable is 1 (ii) exponent of variable is 1
(iii) value of variable is 2.

Which one is correct?

- (a) i and ii (b) i and iii (c) ii and iii (d) i, ii and iii
7. If a, b, c refer to any number and $a = b$,
(i) $ac = bc$ (ii) $a+c = b+c$ (iii) $a-c = b-c$

Which one is correct?

- (a) i and ii (b) i and iii (c) ii and iii (d) i, ii and iii

Answer question 8-9 using the information given below.

The subtraction of two numbers is 30 and the greater number is 4 times the smaller number.

8. What is the ratio of greater and smaller number?
(a) 1:2 (b) 1:4 (c) 2:1 (d) 4:1
9. What is the smaller number?
(a) 6 (b) 10 (c) 27 (d) 40
10. Bimal bought an exercise book and a pencil for 30 taka from a shop. The pencil costs x taka and exercise book costs twice the cost of the pencil. Look at the following data :
- Exercise book costs $3x$ taka.
 - By the question, the equation is $x + 2x = 30$.
 - If the exercise book costs 20 taka, the pencil costs 10 taka.
- According to the above data which one of the following is true ?
a. i and ii b. i and iii c. ii and iii d. i, ii and iii

11. Sum of two natural numbers is 24. Then,
- (1) If one number is 8, which one of the following is the other number?
a. 10 b. 16 c. 20 d. 32
- (2) Twice of which of the following numbers is added to 6, the sum will be the same ?
a. 6 b. 9 c. 12 d. 18
- (3) What is the number when 4 is subtracted from it, their difference will be half of the given sum ?
a. 8 b. 12 c. 16 d. 20

Solve the following equations (12–23) :

- | | | |
|-----------------------|-------------------|-------------------|
| 12. $x + 4 = 13$ | 13. $x + 5 = 9$ | 14. $y + 1 = 10$ |
| 15. $y - 5 = 11$ | 16. $z + 3 = 15$ | 17. $3x = 12$ |
| 18. $2x + 1 = 9$ | 19. $4x - 5 = 11$ | 20. $3x - 5 = 17$ |
| 21. $7x - 2 = x + 16$ | 22. $3 - x = 14$ | 23. $2x + 9 = 3$ |

Solve by forming equation (24–35) :

24. If 6 is added to twice a number, the sum will be 14. What is the number?
25. If 5 is subtracted from a number, the difference will be 11. What is the number ?
26. What is the number whose 7 times will be equal to 21 ?
27. If 3 is added to 4 times a number, the sum will be 23. What is the number ?
28. If 3 times a number is added to 5 times that number, the sum will be 32. Find the number.
29. If twice a number is subtracted from four times the number, the difference will be 24. Find the number.
30. If the price of a pen is less than its specified price by 2 taka, the price would be 10 taka. What is the price of the pen ?

31. Monika has 4 times more chocolates than Kanika. They have 25 chocolates together. How many chocolates does Kanika have ?
32. The sum of two consecutive even natural numbers is 30. Find the numbers.
33. The sum of three consecutive odd natural numbers is 27. Find the numbers.
34. The Length of a rectangular flower garden is 2 metre more than its breadth.
 - a. If the breadth of the garden is x metre, find its perimeter in terms of x .
 - b. If the perimeter of the garden is 36 metre, what is its breadth ?
 - c. It costs 320 taka to clean the garden. What will be the cost to clean per square metre ?
35. The sum of three consecutive natural numbers is 24.
 - a. If the smallest number is x , write down the other two numbers in terms of x .
 - b. From the given facts, determine the three numbers.
 - c. Twice a number y is 4 more than the sum of the obtained smallest and greatest numbers. Determine the value of y .

Chapter Six

Basic Concepts of Geometry

The word 'Geometry' means 'the measurement of earth'. Geometry is the branch of mathematics that deals with the measurement of space. The Greek mathematician Euclid, in thirteen parts of his book 'Elements', in the third century B.C. systematically put down the definitions and principles of Geometry. The main theme of Euclidean geometry is the geometric constructions and logical proof of the correctness of constructions by a few axioms or postulates. Geometry has developed tremendously since then.

At the end of the chapter, the students will be able to

- explain space, surface, line and point.
- differentiate rays from line segment.
- identify the relations between adjacent and vertically opposite angles and apply them.
- explain parallel straight lines.
- identify the angles produced by two parallel straight lines and a transversal.
- explain triangles by sides and angles.
- identify square, rectangle, rhombus and parallelogram.

6.1 Space, surface, line and point

The adjoining diagram represents a brick. The brick occupies some space. Similarly, every object around us occupies some space. An object with length, breadth and height is called a solid body. Examples of solid bodies are a brick, a book, a match box, a piece of wood etc. By space we mean the volume occupied by a body of definite shape.

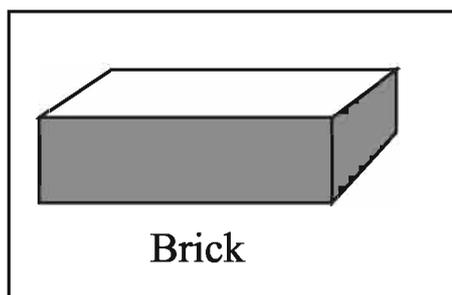

The side of the solid represents a surface. The faces of a brick, the top of a table or page are examples of surfaces. Each of the six faces of a brick represents a plane. When a face meets the other face, an edge is formed. This edge is the segment of a line. Again, three edges of the brick meet at a corner. The corner occupies no space.

It gives the idea of a point which has only existence but no dimensions. A dot made with the tip of a sharp pencil on a piece of paper may be taken as representation of a point. Points are denoted by letters like A, B, P, Q etc.

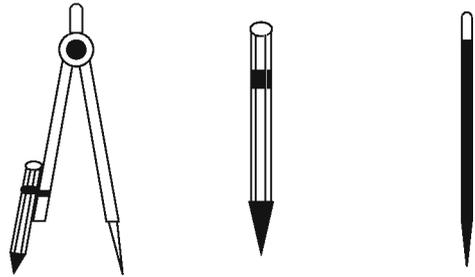

6.2 Line, line segment and ray

Consider two points A and B on a paper. Place the side of a ruler on the points and join these two points by a pencil. Then AB represents the part of a straight line or AB is a line segment. If we extend the line segment in both directions endlessly, we get the representation of a straight line. A straight line has no end points and it has no definite length. But a line segment has both definite end points and definite length.

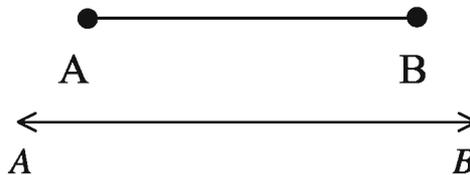

AB is a straight line. A straight line has no width.

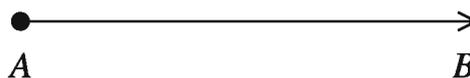

In the diagram, the endless part of the line from A to B is a ray. AB is a ray. A ray has no definite length; it has only one end point.

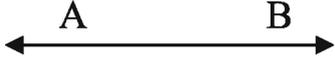
Line	Line segment	Ray
A straight line has no end points.	Line segment has definite length	A ray has no definite length
A straight line has no definite length	Line segment has two end points	A ray has only one end point
 <p style="text-align: center;">Straight line AB</p>	 <p style="text-align: center;">Line segment AB</p>	 <p style="text-align: center;">Ray AB</p>

Important postulates involving points, lines and planes

- (1) One and only one straight line can be drawn through two points.
- (2) The points lying on the same straight line are called collinear.
- (3) The length of the line segment is the distance between its two end points.
- (4) Any point except the end points of a line segment is called an interior point of the line segment. If Q is an interior point of the line segment PR , $PQ + QR = PR$.

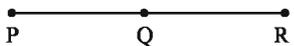
- (5) In a plane two straight lines can intersect each other at one and only one point.
- (6) If two points lie in the same plane, the line joining them lies wholly in the plane.

Activity:

1. How many rays are there in the figure?

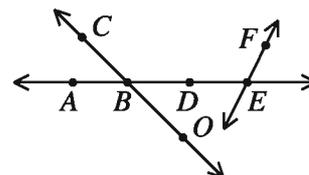
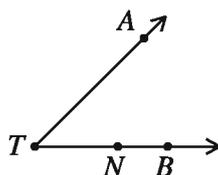

2. What are the differences among a line, a line segment and a ray? Draw and identify a line, a line segment and a ray in a figure.

3. Sketch a box and indicate its planes, line segments and points.
4. Draw two points in your notebook and join them to make a straight line.

6.3 Angles

In a plane, when two rays meet at a point, an angle is formed. The rays are known as the sides of the angle and their common point as vertex. In the adjoining diagram the rays OP and OQ have formed the angle $\angle POQ$ at the vertex O .

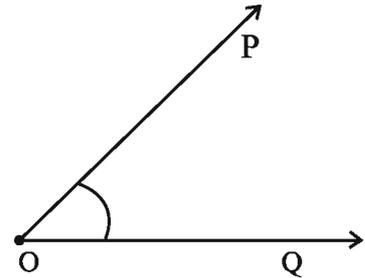

Straight angle

In the adjoining figure, AB is a ray. A ray AC is drawn at A opposite to the ray AB .

The ray AC is called the opposite ray of the ray AB . The rays AB and AC have formed an angle $\angle BAC$ at their common end point A . The $\angle BAC$ is called a straight angle.



The angle formed at the common end point of two opposite rays is called a straight angle.

Adjacent angles :

Two angles $\angle BAC$ and $\angle CAD$ are produced at A . The side AC is common to both the angles. The two angles are on opposite sides of AC . These angles $\angle BAC$ and $\angle CAD$ are adjacent angles.

The angles having a common vertex and a common side and lying next to each other are called adjacent angles.

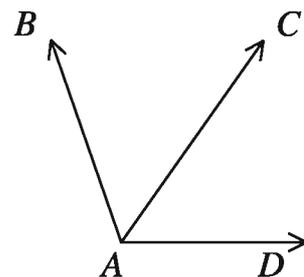

Activity :

1. Measurements of a few angles are given; draw the angles with the help of a protractor
 (a) 30° (b) 45° (c) 60° (d) 90° (e) 120° (f) 180° .
2. Measure and classify the angles :

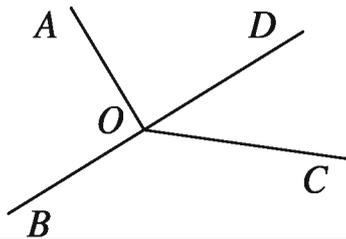

Right angle and Perpendicular

Two angles $\angle BAC$ and $\angle CAD$ are produced at A of the line BD . The point A is their common vertex and the angles lie on the opposite sides of the common side AC . So, the two angles are adjacent angles. If these two angles are equal, each of them is called a right angle. Measurement of a right angle is 90° . Besides, the sides AD and AC (or AB and AC) are called perpendicular to each other.

If two adjacent angles on a line are equal, each of them is called a right angle. The two sides of a right angle are mutually perpendicular.

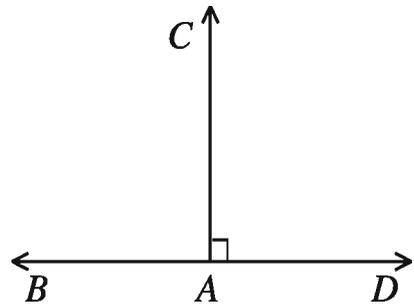

Complementary Angles:

In the adjoining picture, $\angle AOB$ is a right angle. The ray OC is within the sides of the right angle. Thus two adjacent angles $\angle AOC$ and $\angle COB$ are produced. The sum of the measurements of the two angles is equal to the measurement of $\angle AOB$, i.e. 90° . $\angle AOC$ and $\angle COB$ are complementary angles. If the sum of the measurements of two angles is 90° , the angles are complementary to each other.

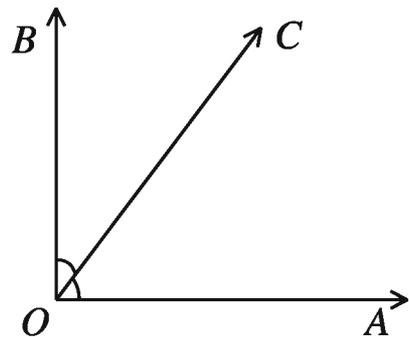

Supplementary Angles :

AB is a straight line. The ray OC meets AB at O . Thus two adjacent angles $\angle AOC$ and $\angle COB$ are produced. The sum of the measurements of the two angles is equal to the measurement of the straight angle $\angle AOB$, i.e. 180° . The two angles are supplementary angles to each other, or simply, supplementary.

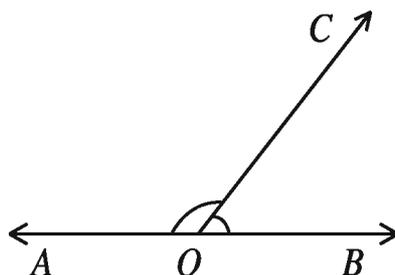

If the sum of the measurements of two angles is 180° , the angles are supplementary to each other.

- If the sum of two angles is 90° , one is complementary to the other.
- If the sum of two angles is 180° , one is supplementary to the other.
- Two supplementary angles drawn as adjacent angles produce a straight angle.

Vertically opposite angles:

AB and CD are two straight lines. They intersect each other at the point O . Thus, the angles $\angle AOC$, $\angle COB$, $\angle BOD$ and $\angle DOA$ are formed. The vertex O is common to all the angles. Among these angles, $\angle AOC$ and $\angle BOD$ are vertically opposite angles. Similarly, $\angle BOC$ and $\angle DOA$ are vertically opposite angles.

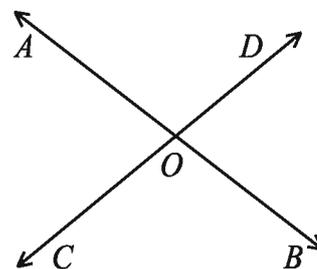

The rays OA and OB are opposite rays, since the three points A, O, B lie on the same straight line. Similarly, OC and OD are opposite rays. The angle $\angle BOD$ is produced by the rays OB and OD . Its vertically opposite $\angle AOC$ is produced by the two rays OA and OC - the rays opposite to OB and OD .

- The angle produced by the two opposite rays of the sides of an angle is the vertically opposite angle.
- Two pairs of vertically opposite angles are produced at the point of intersection of two straight lines.
- The sides of a pair of vertically opposite angles are two intersecting straight lines with the vertex as the point of intersection.

Observe: Any angle is equal to its vertically opposite angle.

Activity:

1. Measure and classify the identified angles in the adjacent figure.

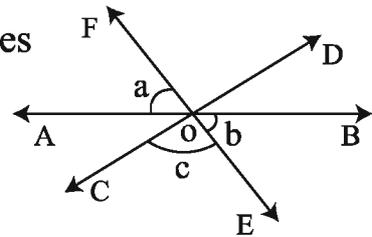

Theorem 1

The sum of two adjacent angles produced by a ray, when it meets with a straight line, is equal to two right angles.

The ray OC meets the straight line AB at O .
 As a result, two adjacent angles $\angle AOC$ and $\angle COB$ are formed. We want to prove that $\angle AOC + \angle COB = 2$ right angles.

Draw a perpendicular DO to AB .

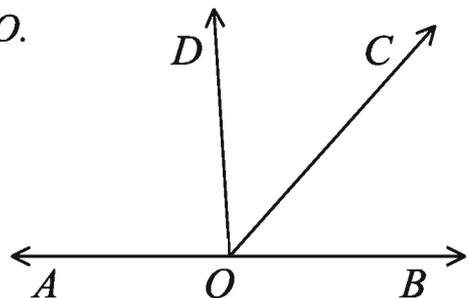

$$\begin{aligned}
 \text{Now, } \angle AOC + \angle COB &= \angle AOD + \angle DOC + \angle COB \\
 &= \angle AOD + \angle DOB \\
 &[\text{Since } \angle DOC + \angle COB = \angle DOB] \\
 &= 1 \text{ straight angle} + 1 \text{ straight angle} = 2 \text{ right angles. [Proved]}
 \end{aligned}$$

Theorem 2

When two straight lines intersect, the vertically opposite angles are equal.

Let AB and CD be two straight lines, which intersect at O . As a result, the angles $\angle AOC$, $\angle COB$, $\angle BOD$, $\angle AOD$ are formed. We want to prove that $\angle AOC = \angle BOD$ and $\angle COB = \angle AOD$.

Now, the ray OA meets the line CD at O .

So $\angle AOC + \angle AOD = 1$ straight angle = 2 right angles.

Similarly, the ray OD meets the line AB at O .

So, $\angle AOD + \angle BOD = 1$ straight angle = 2 right angles.

Thus, $\angle AOC + \angle AOD = \angle AOD + \angle BOD$.

$\therefore \angle AOC = \angle BOD$ [Omitting $\angle AOD$ from both sides]

Similarly, we can prove that $\angle COB = \angle AOD$. [Proved]

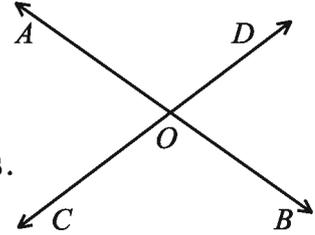

6.4 Parallel lines

Two straight lines in a plane are parallel if they do not meet or intersect. If the perpendicular distances from any two points on one line to the other are equal, the lines are parallel. Two parallel lines never intersect each other.

Parallel lines and perpendicular distances

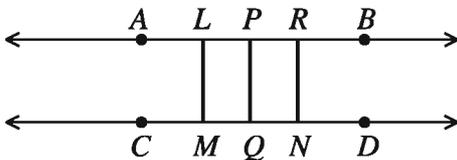

In the figure above, two straight lines AB and CD are parallel to each other. The perpendiculars LM , PQ , RN are drawn from the points L , P , R on the line AB to the line CD . The lengths of LM , PQ , RN , if measured with a ruler, are found to be equal. The length of any other perpendicular will also be of the same measure. This is a characteristic property of parallel lines.

By perpendicular distance between two parallel lines we mean the perpendicular distance from a point on one of the lines to the other.

Note that only one straight line can be drawn parallel to a given straight line through a point not on the line.

Parallel lines and transversals

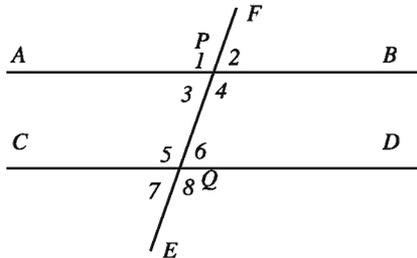

In the figure, two straight lines AB and CD are cut by a straight line EF at points P and Q . The straight line EF is called a transversal of AB and CD . The transversal has made eight angles $\angle 1, \angle 2, \angle 3, \angle 4, \angle 5, \angle 6, \angle 7, \angle 8$ with the lines AB and CD . Among the angles

- (a) $\angle 1$ and $\angle 5, \angle 2$ and $\angle 6, \angle 3$ and $\angle 7, \angle 4$ and $\angle 8$ are corresponding angles,
- (b) $\angle 3$ and $\angle 6, \angle 4$ and $\angle 5$ are alternate angles,
- (c) $\angle 4, \angle 6$ are interior angles on the right
- (d) $\angle 3, \angle 5$ are interior angles on the left.

Measure the corresponding angles with a protractor to see that they are equal. Also show that the alternate angles are also equal. These are some special properties of straight lines.

Activity:

1. Two straight lines AB and CD are parallel. Find the measure of the angles a, b, c, d .

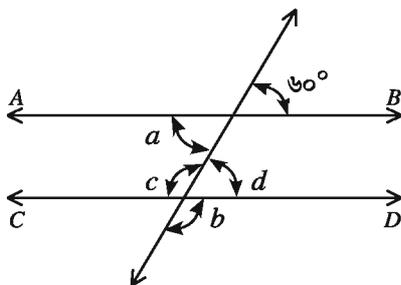

Exercise 6.1

1. Answer the following questions:



- (a) How many line segments can be drawn by the three points? Write down their names.
- (b) How many lines can be drawn by the three points? Write down their names.
- (c) How many rays can be drawn by the three points? Write down their names.

2. In the figure which pair of angles represent the correct pair of alternate angles?

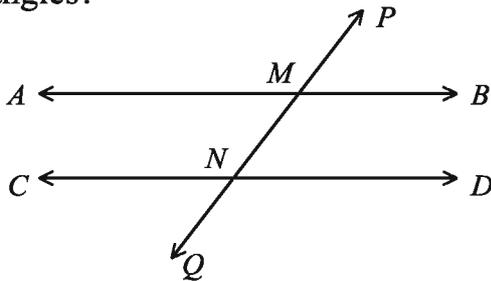

- (a) $\angle AMP, \angle CNP$
- (b) $\angle BMP, \angle BMQ$
- (c) $\angle CNP, \angle BMQ$
- (d) $\angle BMP, \angle DNQ$

3. In the adjoining figure
 $a = ?$
 $b = ?$
 $c = ?$
 $d = ?$

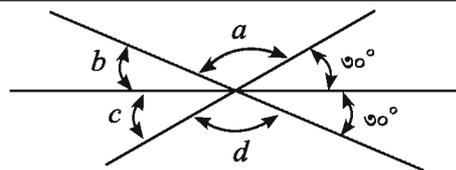

4. Prove that the bisectors of the vertically opposite angles is a straight line.

5. Prove from the adjoining figure that

$$\angle x + \angle y = 90^\circ.$$

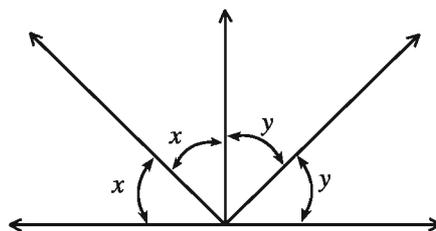

6.5 Triangles

A triangle is a figure closed by three line segments. The line segments are known as sides of the triangle. The point common to any pair of sides is a vertex. The sides form angles at the vertices. A triangle has three sides and three angles. The sum of the lengths of three sides of the triangle is the perimeter. By a triangle we also denote the region closed by the sides.

In the figure ABC is a triangle. A, B, C are three vertices. AB, BC, CA are three sides and $\angle BAC, \angle ABC, \angle BCA$ are three angles of the triangle. The sum of the measurements of AB, BC and CA is the perimeter of the triangle.

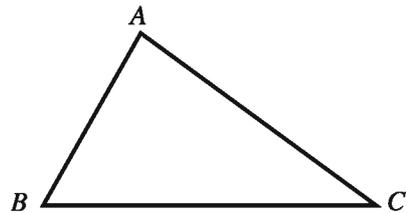

In respect of sides, the triangles are of three types : equilateral, isosceles, scalene.

Equilateral Triangle

An equilateral triangle is a triangle of equal sides. The triangle ABC is an equilateral triangle, because, side $AB =$ side $BC =$ side CA .

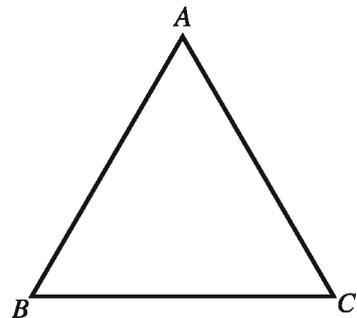

Isosceles Triangle

Only two sides of an isosceles triangle are equal. The triangle ABC is an isosceles triangle, because side $AB =$ side $CA \neq$ side BC .

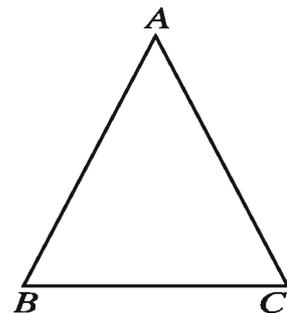

Scalene Triangle

Sides of a scalene triangle are unequal. The triangle ABC is a scalene triangle since measures of its sides AB , BC , CA are unequal.

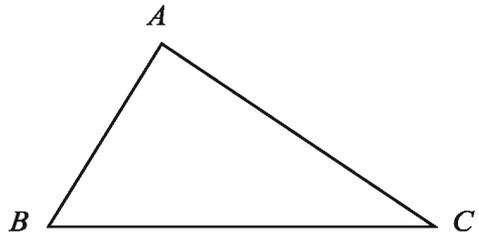

Activity:

1. On assumption, draw an equilateral, an isosceles and a scalene triangle. In each case measure the lengths of three sides of the triangle and note it down.
2. Identify the following triangles by sides.

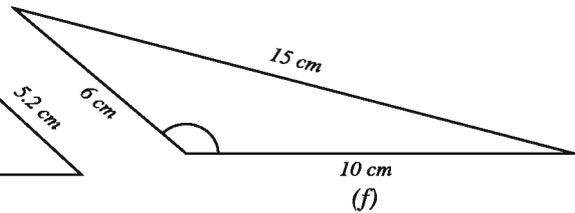
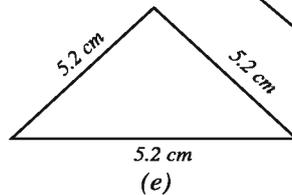
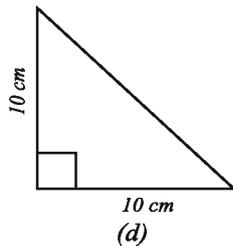
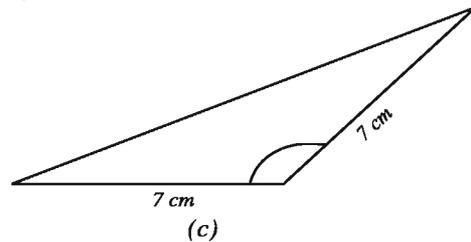
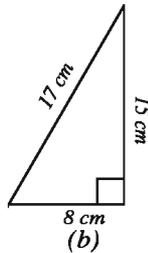
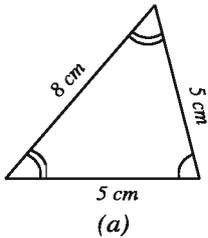

Triangles are of three types in respect of angles: acute angle, right angle and obtuse angle.

Acute angled triangle

A triangle having all the three angles acute is acute angled triangle. In the figure, the triangle ABC is acute angled. Measure the three angles with a protractor to see that each of them is acute, i.e. less than 90° . Therefore, $\triangle ABC$ is an acute angled triangle.

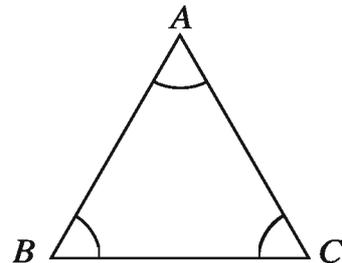

Right angled triangle In the figure, the $\angle DFE$ is a right angle; the two other angles are acute. The triangle DEF is a right angled triangle. A triangle with one right angle, is a right angled triangle.

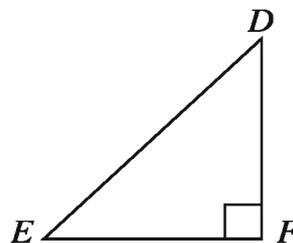

Obtuse angled triangle

In the figure, the $\angle GKH$ is an obtuse angle; the two other angles $\angle GHK$ and $\angle HGK$ are acute. The triangle GHK is an obtuse angled triangle.

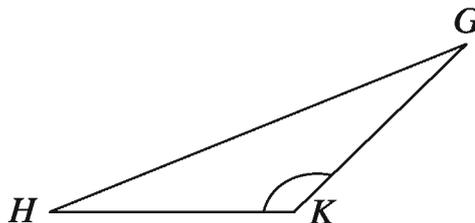

A triangle with one of the angles obtuse, is an obtuse angled triangle.

Each of the three angles of an acute angled triangle is acute.
 One angle of a right angled triangle is a right angle, two other angles are acute.
 One angle of an obtuse angled triangle is an obtuse angle, two other angles are acute.

Activity:

1. On assumption, draw an acute, a right and an obtuse angled triangle.
 - (a) In each case, measure and note down the lengths of the sides.
 - (b) In each case, measure and note down the angles. Find the sum of the three angles and see whether they are equal.
2. Match:

Characteristics of triangle	Types of triangle
(i) Three equal sides	(a) scalene
(ii) Two equal sides	(b) right angled isosceles
(iii) Three unequal sides	(c) obtuse angled
(iv) Three acute angles	(d) right angled
(v) One right angle	(e) equilateral
(vi) One obtuse angle	(f) acute angled
(vii) One right angle and two equal sides	(g) isosceles

6.6 Quadrilateral

A quadrilateral is a figure closed by four line segments. The line segments are the sides of the quadrilateral.

In the adjoining figure, $ABCD$ is a quadrilateral. AB , BC , CD and DA are four sides of the quadrilateral.

The four vertices of the quadrilateral are A, B, C and D . The angles $\angle ABC$, $\angle BCD$, $\angle CDA$ and $\angle DAB$ are four angles. The line segments AC and BD are two diagonals of the quadrilateral. We often denote the quadrilateral $ABCD$ by $\square ABCD$.

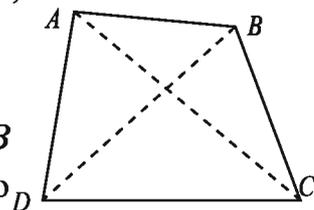

Activity:

1. On assumption, draw a quadrilateral.
 - (a) Measure and note down the lengths of its four sides.
 - (b) Measure and note down its four angles. Find the sum of the four angles.

Quadrilaterals are classified by different characteristics.

Parallelogram

A parallelogram is a quadrilateral with opposite sides parallel. In the figure, $ABCD$ is a parallelogram. Measure and notice that lengths of any two opposite sides are equal:

$AB = CD$ and $BC = AD$. Also measure the four angles with a protractor to see that $\angle DAB = \angle BCD$ and $\angle ABC = \angle CDA$.

But the pairs $\angle DAB, \angle BCD$ and $\angle ABC, \angle CDA$ are vertically opposite angles. So

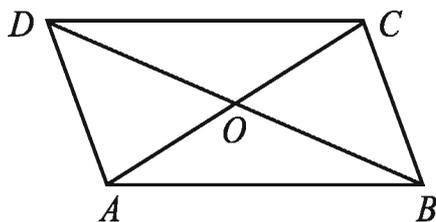

the opposite sides and angles of a parallelogram are equal. We can construct a parallelogram by two identical set-squares, as shown in the figure.

Now draw the diagonals of the parallelogram. They intersect at O .

Measure the lengths of AO and OC and observe that they are equal. Similarly, the line segments BO and OD are also equal. Therefore, the diagonals of a parallelogram bisect each other.

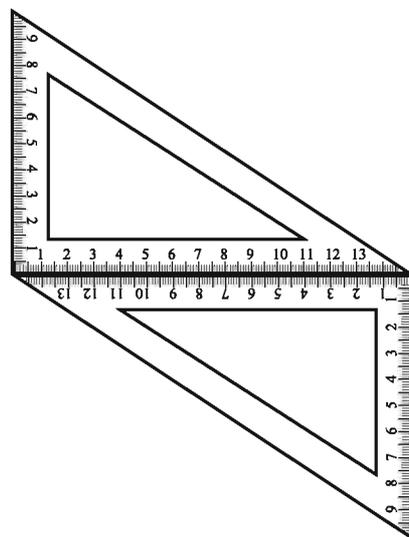

Rhombus

A rhombus is a parallelogram with equal sides. So, the opposite sides of a rhombus are parallel and all the four sides are equal.

In the figure, $ABCD$ is a rhombus. All the sides of a rhombus are equal and the opposite angles are equal as well. The diagonals AC and BD bisect each other at O . Measure the angles $\angle AOB$, $\angle BOC$, $\angle COD$, $\angle DOA$ with a protractor and see that each of them is a right angle. We can easily construct a rhombus by four identical set-squares as shown in the figure.

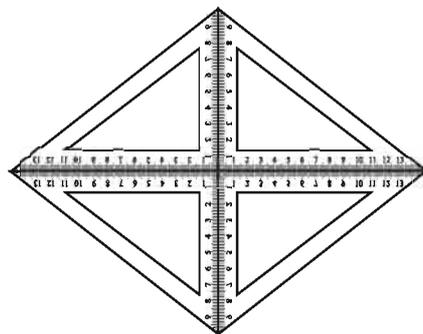
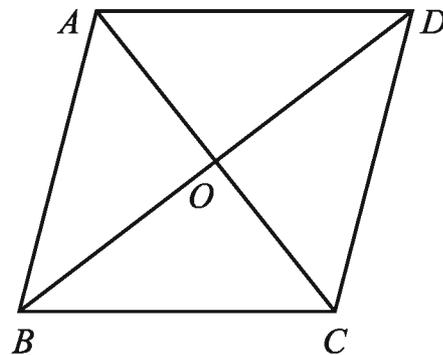

Rectangle

A rectangle is a parallelogram with one right angle. Also, a parallelogram with all right angles is a rectangle. In the adjoining figure, $ABCD$ is a rectangle. Notice that if one of the angles of a parallelogram is a right angle, the others are right too. Thus, all the angles of a rectangle are right angles and the opposite sides are equal. The diagonals of a rectangle are equal and bisect each other. We can easily construct a rectangle by two identical set-squares as shown in the figure.

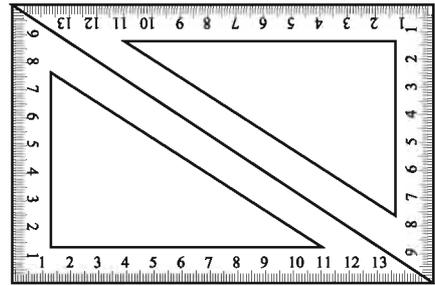
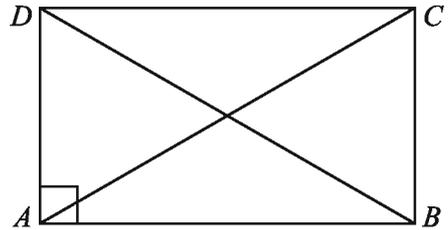

Square

A square is a rectangle with equal sides. So, a square is a parallelogram with all sides equal and all angles right. In the adjoining figure, $ABCD$ is a square. The opposite sides of a rectangle are equal. So, if any two adjacent sides of a rectangle are equal, it becomes a square. Therefore, a square is a rectangle with any two adjacent sides equal. Put it in other way, a square is a parallelogram with two adjacent sides equal and one right angle. The sides of a square are all equal and all the angles are right angles. On the other hand, the square is a rhombus as well. The diagonals of a square are equal and they bisect perpendicularly. We can easily draw a square by two similar set-squares.

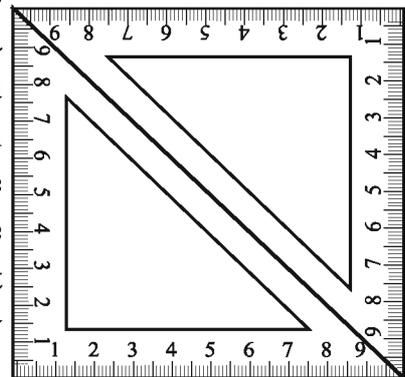
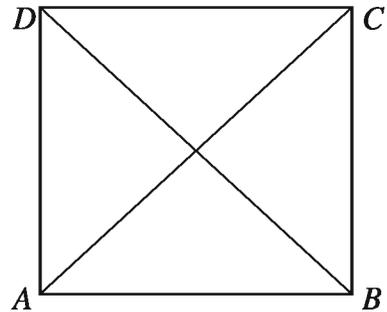

Activity:

1. On assumption, draw a parallelogram, a rhombus and a rectangle.
 - (a) In each case, measure the lengths of opposite sides and see whether they are equal.
 - (b) In each case, measure the lengths of the opposite angles and see whether they are equal.
 - (c) In each case, measure and see whether the diagonals are bisected at the point of intersection.
 - (d) In case of rhombus, also measure the angles at the point of intersection of the diagonals and see whether they intersect perpendicularly.

Exercise 6.2

1. Fill in the gaps:

- (a) The measure of a right angle is ----- .
- (b) The measure of an acute angle is ----- than that of a right angle.
- (c) The measure of an obtuse angle is ----- than that of a right angle.
- (d) An angle of a right angled triangle is ----- and the other two angles are ----- angles.
- (e) ----- triangle has an obtuse angle and ----- acute angles.
- (f) A triangle having all the angles less than ----- is an acute angled triangle.

2. Which country did the scholar Euclid belong to ?

- (a) Italy (b) Germany (c) Greece (d) Spain

3. What is the name of the book written by Euclid on the theme of geometry?

- (a) Algebra (b) Elements (c) Geometry (d) Mathematic

4. In which century B.C. did Euclid put down the definition of geometric measurement process and different procedures in his book 'Elements' ?

- (a) 300 (b) 400 (c) 500 (d) 600

5. Draw the following angles:

- (a) 30° (b) 45° (c) 60° (d) 75° (e) 85° (f) 120° (g) 135° (h) 160°

6. On assumption, draw acute, obtuse and right angled triangles.
 (a) In each case measure the lengths of their sides.
 (b) In each case measure the three angles and put it down in your notebook. Verify whether the sum of three angles is always the same.
7. The measurement of a few angles are given below. In each case, find the corresponding complementary angle and draw it.
 (a) 60° (b) 45° (c) 72° (d) 25° (e) 50°
8. The measurement of a few angles are given below. In each case, find the corresponding supplementary angle and vertically opposite angle in the same figure. Also, mark the vertically opposite angle of the supplementary angle.
 (a) 45° (b) 120° (c) 72° (d) 110° (e) 85°

9.

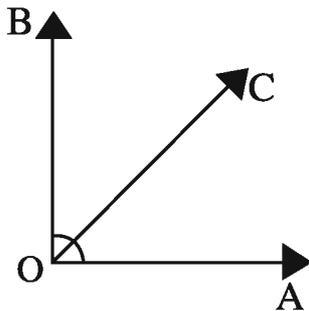

In the figure $\angle AOB = 90^\circ$

- (i) $\angle AOC + \angle BOC = 90^\circ$
 (ii) $\angle AOC + \angle BOC = \angle AOB$
 (iii) $\angle AOC$ and $\angle BOC$ are supplementary angles

Which one is correct?

- (a) i and ii (b) i and iii (c) ii and iii (d) i, ii and iii

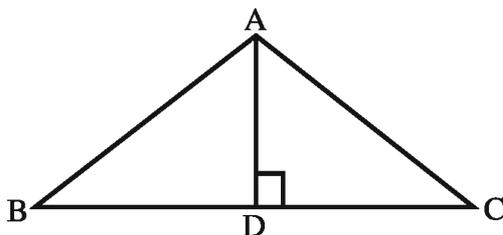

In the figure, of $\triangle ABC$, $\angle BAC = 120^\circ$ and $AD \perp BC$
Answer question 10-12 in the light of the figure.

10. $\angle ADC = ?$
(a) 30° (b) 45° (c) 60° (d) 90°
11. What is the complementary angle of $\angle ABD$?
(a) $\angle ADB$ (b) $\angle CAD$ (c) $\angle BAD$ (d) $\angle ACD$
12. Which one is the straight angle?
(a) $\angle ADB$ (b) $\angle CAD$ (c) $\angle ACD$ (d) $\angle BDC$
13. A line-
(i) has no definite length (ii) has no end points
(iii) has no definite breadth
Which one is correct?
(a) i and ii (b) i and iii (c) ii and iii (d) i, ii and iii
14. Draw a few right angled triangles. In each triangle, measure and add the angles other than the right angle. In each case, what is the sum of the three angles?
15. Draw a quadrilateral and measure the lengths of its four sides and two diagonals. Also, measure the four angles of the quadrilateral and find their sum.
16. On assumption, draw two quadrilaterals with sides of different lengths.
(a) In each case, measure the lengths of its four sides and two diagonals and note it down.
(b) Measure the four angles of each quadrilateral and see whether the sum of four angles is identical.
17. On assumption, draw a square with sides of length 4 cm.
(a) Measure the length of both diagonals and note it down.
(b) Locate the mid-points of the sides and join successively. How does the quadrilateral look like? Measure the length of its sides and angles.

18. On assumption, draw a parallelogram with two adjacent sides of length 4 cm and 3 cm. Measure the length of their opposite sides. Also, measure the pair of opposite angles. Draw the two diagonals of the parallelogram and find the length of the four segments at the point of intersection of the diagonals.

19. In the figure, $AB \parallel CD$ and $EF \parallel GH$

(a) Write down the name of the quadrilateral PQRS with reasons.

(b) Taking four angles from the figure, find their complementary angles and alternate angles.

(c) Prove that $\angle APE = \angle DRH$.

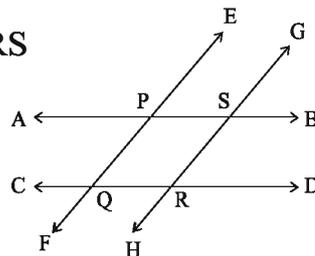

20. The lines AB and CD intersect at the point O .

(a) Based on the above information, draw a figure.

(b) Prove that, the produced vertically opposite angles are equal to each other.

(c) If $\angle AOC = (4x-16)$ and $\angle BOC = 2(x+20)$, determine the value of x .

Chapter Seven

Practical Geometry

We see many objects of different shapes and sizes around us. Some of them are square, some are rectangular and some are circular. In this chapter we shall learn to draw these shapes.

The students, at the end of the chapter, will be able to

- measure a line segment.
- use information to draw line segments.
- draw figures of different measurement.

7.1 Line

In making geometrical shapes we need to use some tools. We shall begin with listing these tools, describing them and looking at how they are used.

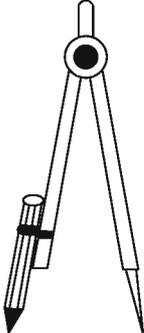
	Name, Figure and Use	Description
1.	<p>1. The Ruler</p>  <p>To draw and measure line segments</p>	<p>The ruler is graduated into their lengths, centimetres along one edge and inches along the other edge.</p>
2.	<p>The Pencil-compass</p>  <p>To draw arcs and circles</p>	<p>A Pencil-compass consists of a pair of arms with pointer on one end and a pencil on the other. The pencil is fastened in such a way that equal length of each arm is maintained. The two arms of the pencil-compass are fixed with a screw in such a way that the distance between the tips of the arms can be varied.</p>

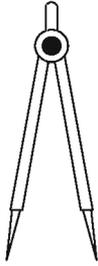
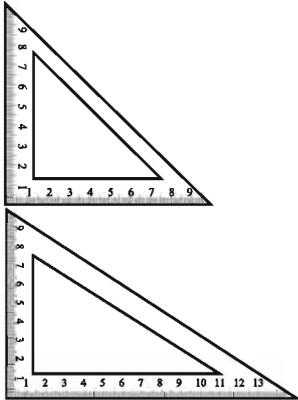
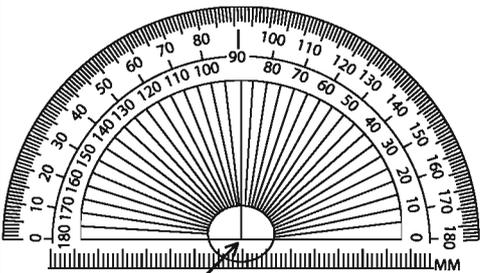
3.	<p>The Divider</p>  <p>To mark off equal lengths</p>	<p>A pair of pointers of equal length are fixed together with a screw in such a way that the distance between the pointers can be extended or reduced as desired.</p>
4.	<p>Set-squares</p>  <p>To draw perpendicular and parallel lines.</p>	<p>Set- squares are two triangular pieces – one of them has 45°, 45°, 90° angles at the vertices and the other has 30°, 60°, 90° angles at the vertices. The adjacent sides of the right angle are marked in centimetres.</p>
5.	<p>The Protractor</p>  <p>To draw and measure angles.</p>	<p>A protractor is a semi-circular device graduated into 180° parts. The measure starts from 0° on the right hand side and ends with 180° on the left hand side and vice-versa.</p>

We are going to draw geometrical figures using ruler and compass. We use ruler to draw lines and compass to draw arcs only. Be careful while doing these constructions. Here are some tips for you.

- Draw thin lines and mark points lightly.
- Maintain instruments with sharp tips and fine edges.
- Have two pencils in the box, one to insert into the compass and the other to draw lines or curves and mark points.

Construction 1

Construction of a line segment of a given length

Suppose we want to draw a line segment of length 4.7 cm. We can use our ruler to mark two points A and B which are 4.7 cm apart. Join A and B and get AB .

Use of ruler and compass

A better method would be to use compass to construct a line segment of a given length.

Step 1 Draw a line segment and mark a point A on a line segment.

Step 2 Place the compass pointer on the zero mark of the ruler. Open it to place the pencil point up to the 4.7 cm mark.

Step 3 Take out the compass carefully so that the opening of the compass has not changed. Place the pointer on A and swing an arc to cut the line segment at B .

Step 4 AB is a line segment of required length 4.7 cm.

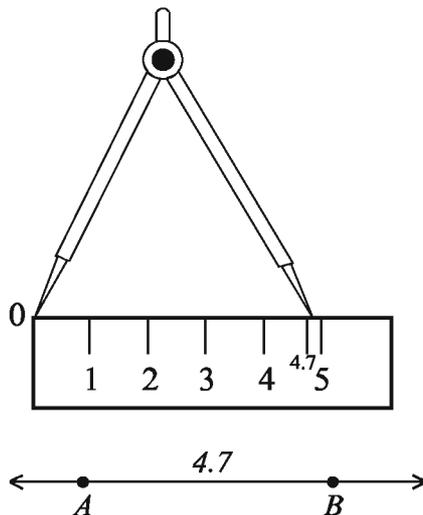

Construction 2

Construction of a copy of a given line segment

Suppose AB is a given line segment. You want to draw a line segment whose length is equal to the given line segment AB . A quick and natural approach is to use your ruler to measure the length of AB and then use the same length to draw another line segment CD . A better approach would be to use ruler and compass for making this construction.

By the use of ruler and compasses

Follow the following steps to make a copy of AB whose length is not known.

Step 1 Draw a line segment AB of a convenient length.

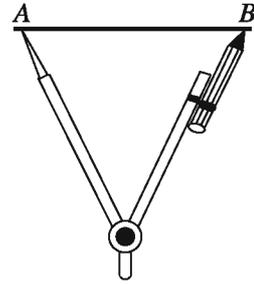

Step 2 Place the pointer of the pencil-compass on A and the pencil end on B . The opening of the instrument now gives the length of AB .

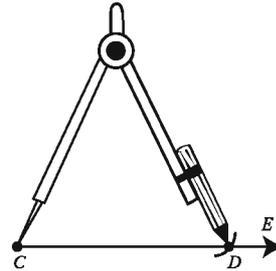

Step 3 Draw any ray CE . Choose a point C on the ray. Without changing the compass setting, place the pointer on C . Swing an arc taking equal radius of AB line segment that cuts the ray CE at a point, say, D . Now CD is a copy of AB .

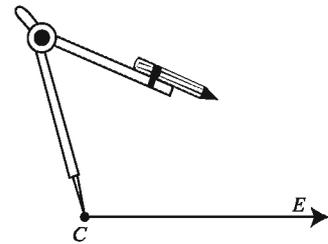
**Activity**

1. Draw a line segment of the length 7 cm. Use a ruler and a compass to draw a copy of this line segment and verify that the length of the copy is really 7 cm.

Construction 3**The perpendicular bisector of a line segment**

Suppose AB is a given line segment. Follow the steps below to bisect the line segment:

Step 1 Draw a line segment AB of any length.

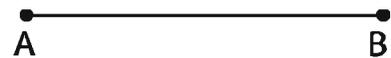

Step 2 With A as centre, using a pencil-compass, draw two arcs on both sides of AB . The radius of your circle should be more than half the length of AB .



Step 3 With the same radius and with B as the centre, draw another half circle using the compass. Let it cut the previous circle at C and D .

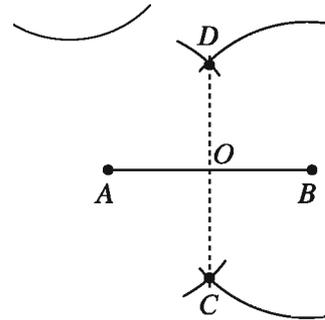

Step 4 Join C, D . It cuts AB at O . The point O bisects the line segment AB .

Activity

1. Draw a line segment of length 7 cm using a ruler. Use the ruler and the compass to bisect the line segment and verify whether the lengths of the two segments are really equal.
2. Use the ruler to draw a line segment of length 8 cm. Also, use the ruler and the compass to divide the line segment into four equal parts.

7.2 Perpendiculars

You know that two lines (or rays or segments) are said to be a perpendicular if they intersect so as to angles formed between them are right angles. The corners of your textbook indicate lines meeting at the right angles.

Do Yourself

Take a piece of paper. Fold it along the middle and make the crease. Fold the paper once again down the middle in the other direction. Make the crease and open out the page. The two creases are perpendicular to each other.

Construction 4

Perpendicular to a line through a point on it

Method 1. (Using ruler and a set-square)

Follow the following steps:



Step 1 A line segment AB and a point P are given. Note that P is on the line segment.

Step 2 Place a ruler with one of its edges along AB . Hold this firmly.

Step 3 Place a set-square with one of its edges along the already aligned edge of the ruler in such way that the right-angled corner is in contact with the ruler. Slide the set-square along the edge of ruler until its right-angled corner coincides with P .

Step 4 Hold the set-square firmly in this position. Draw PQ along the other edge of the set-square. Then PQ is perpendicular to AB . That is, $PQ \perp AB$.

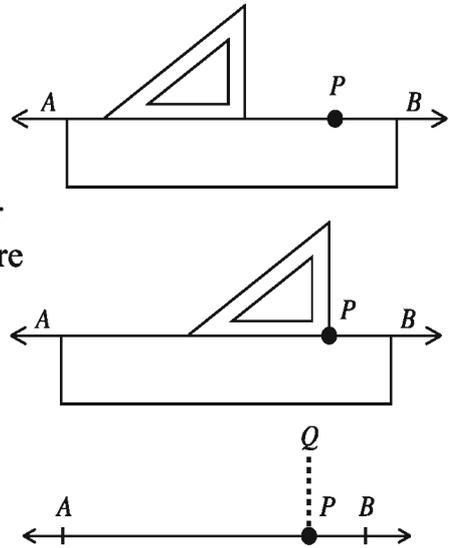

Observe: The symbol \perp is used to denote a perpendicular.

Activity

1. With a ruler and a set-square, draw a perpendicular to a line segment through a point on it. Verify with a protractor that the perpendicular line really passes through the mark of 90° .

Method 2

(Ruler and compass method)

The drawing of a perpendicular can be achieved through the 'ruler-compass' construction as follows :

Step 1 Given a point P on a line AB .

Step 2 With P as the centre and with convenient radius, construct an arc intersecting the line at two points A and B .

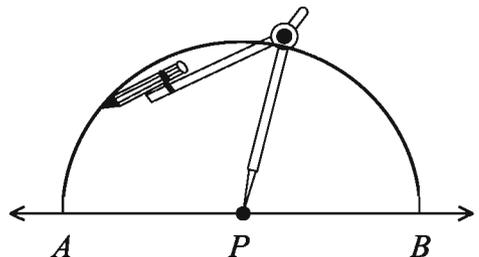

Step 3 With A and B as centres and a radius greater than AP construct two arcs which cut each other at Q .

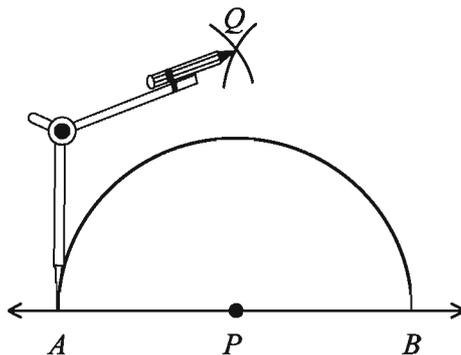

Step 4 Join PQ . Then PQ is perpendicular to AB . We denote it by $PQ \perp AB$.

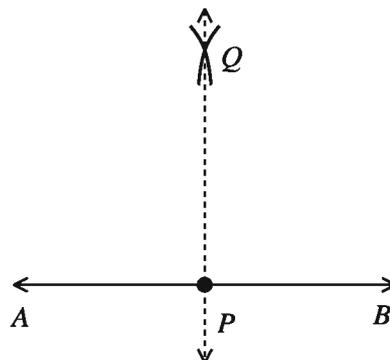

Activity

1. Use a ruler and a compass to draw a perpendicular bisector of a line segment of 6.8 cm in length.
2. Draw a perpendicular CD to a point C of a line AB . Again, take any other point E on the same line AB and draw a perpendicular at E . How do the perpendiculars look like?

Method 3

(Second method using ruler and compasses)

The drawing of a perpendicular can also be done through the ‘ruler-compass’ construction as follows:

Step 1 Draw any line AB and take a point P on it.

Step 2 Place the pointer of the compass at P and draw an arc of convenient radius which cuts the line at C .

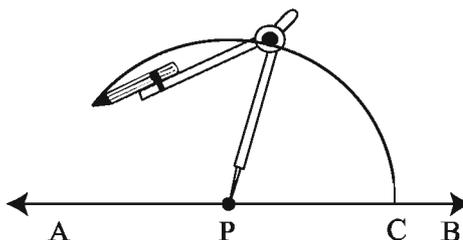

Step 3 Without changing the radius, draw an arc with C as the centre which cuts the first arc at D . Again with the same radius on the compass and with D as the centre, draw an arc which cuts the first arc at E .

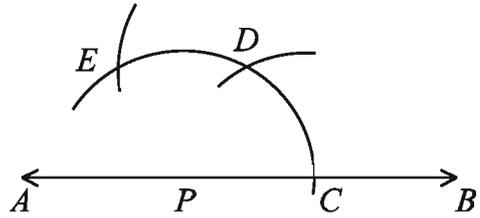

Step 4 With the same radius on the compass and with D and E as the centre, draw two arcs on the same side, which cut at Q .

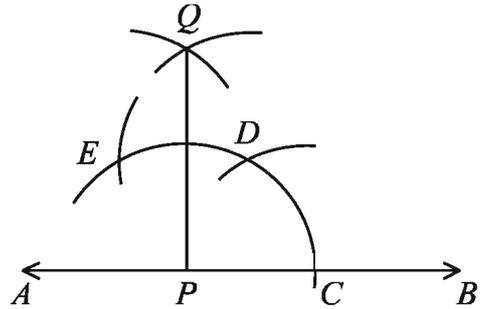

Step 5 Join Q and P . QP is the required perpendicular on AB at P , i.e. $QP \perp AB$.

Activity

1. Use ruler and compass to draw a perpendicular bisector of a line segment of 8 cm in length.
2. Draw a perpendicular CD to a point C on a line AB . Again, take any other point E on CD and draw a perpendicular at E . How do the perpendiculars look like?

Construction 5

Perpendicular to a line through a point not on it

Method 1. Using a ruler and a set-square

A perpendicular from an external point can also be drawn by the 'ruler-set-square' construction through the following steps:

Step 1 Let AB be the given line and P be a point outside it.

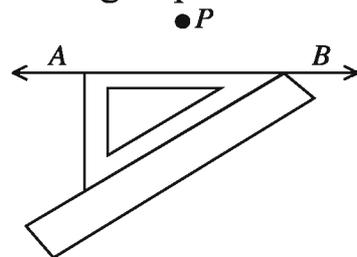

Step 2 Place a set-square on AB in such a way that one arm of its right angle aligns along AB .

Step 3 Place a ruler along the edge opposite to the right angle of the set-square.

Step 4 Hold the ruler fixed and slide the set-square along the ruler till the point P touches the other arm of the set-square.

Step 5 Join PM along the edge through P , meeting AB at M . Now $PM \perp AB$.

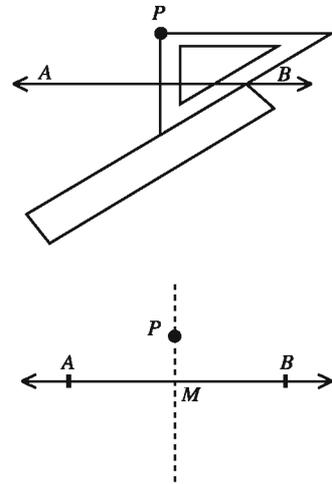

Activity

1. By folding a sheet of paper, draw a perpendicular to a line through a point not on the line.

Method 2

(Method using ruler and compass)

A perpendicular from an external point can also be drawn through the ‘ruler compass’ construction, which is more convenient and accurate.

The steps are:

Step 1 Given a line AB and a point P is out side the line AB .

Step 2 With P as the centre, draw an arc with suitable radius, which intersects line AB at two points X and Y .

Step 3 Using the same radius and with X and Y as the centre, construct two arcs that intersect at a point, say Q , on the other side.

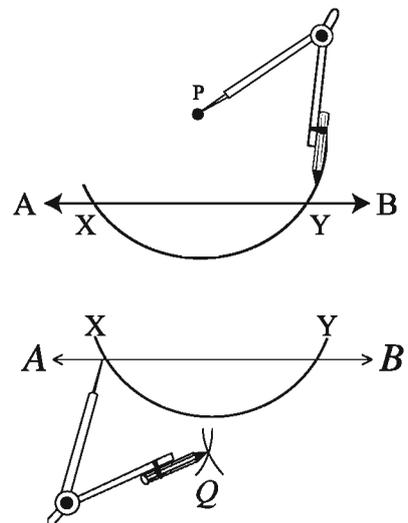

Step 4 Join PQ . Thus, the ray PQ is perpendicular to AB .

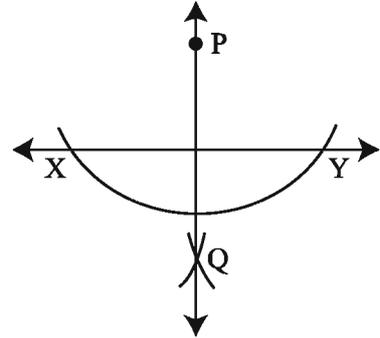

7.3 Drawing of Angles

Construction 6

Constructing an angle of a given measure

Suppose, we want an angle of 40° . Here are the steps for constructing an angle of 40° .

Step 1 Draw AB of any length.

Step 2 Place the centre of the protractor at A and the zero edge along AB .

Step 3 Start with zero near B . Mark point C at 40° .

Step 4 Join AC . Then $\angle BAC$ is the required angle.

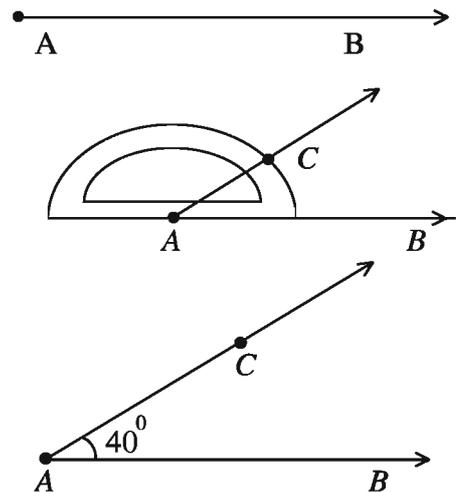

Construction 7

Constructing a copy of a given angle

Given the angle $\angle A$. We want to make a copy of it. The steps are:

Step 1 Draw a ray PQ and choose the point P on it.

Step 2 Place the compass at A and draw an arc of any radius to cut the rays of $\angle A$ at B and C .

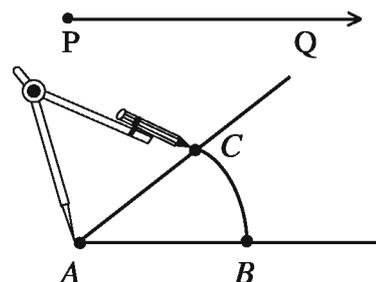

Step 3 Use the same compass setting to draw an arc with P as the centre, cutting PQ at Q .

Step 4 Set your compass to the length BC . Place the compass pointer at Q and draw an arc to cut the arc drawn earlier at R .

Step 5 Join PR . This gives us $\angle RPQ$. It has the same measure as $\angle A$. This means $\angle RPQ$ has same measure as $\angle A$.

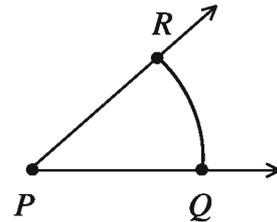
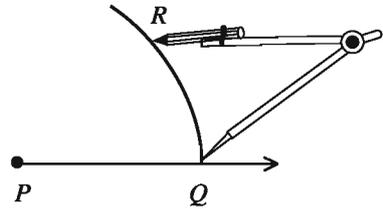

Activity

1. Take a point O on a sheet of paper. With O as the initial point, draw two rays OA and OB to get $\angle AOB$. Fold the sheet through O such a way that the rays OA and OB coincide. Let OC be the crease of paper which you see after unfolding the paper. Measure $\angle AOC$ and $\angle COB$ with a protractor. Are they equal? OC is known as the angle bisector of $\angle AOB$.

Construction 8

Construction of the bisector of an angle

(Construction with ruler and compasses)

Let an angle, say, $\angle BAC$ be given. Find the angle bisector with a ruler and a compasses.

Step 1 With A as the centre and using the compasses, draw an arc that cuts both rays of $\angle A$ at B and C .

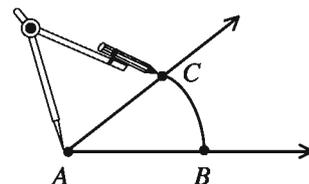

Step 2 With B as the centre, draw an arc in the interior of $\angle A$ whose radius is more than half of the length BC .

Step 3 With the same radius and with C as the centre, draw another arc in the interior of $\angle A$. Let the two arcs intersect at D . Then the line segment AD is the required bisector of $\angle A$.

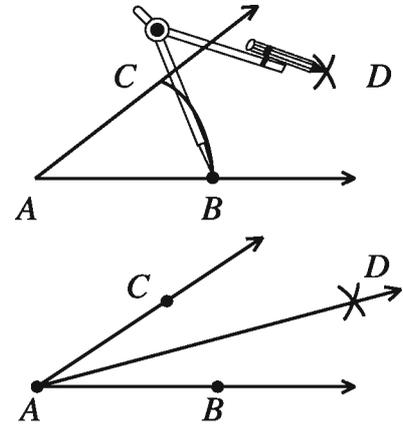

Activity

1. In Step 2 above, what would happen if we take radius smaller than half of the length BC ?

Angles of special measures

There are some elegant and accurate methods to construct some angles of special sizes which do not require the use of the protractor. Examples of such angles are 60° , 120° , 30° , 45° etc.

Construction 9

Constructing a 60° angle

Follow the steps below to construct a 60° angle:

Step 1 Draw a line l and mark a point O on it.



Step 2 Place the pointer of the compass at O and draw an arc of convenient radius. The arc cuts the line PQ at a point say, A .

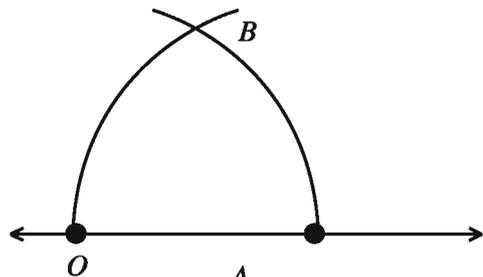

Step 3 With the pointer at A as the centre, draw an arc that passes through O .

Step 4 Let the two arcs intersect at B . Join O , B . We get $\angle BOA$ whose measure is 60° .

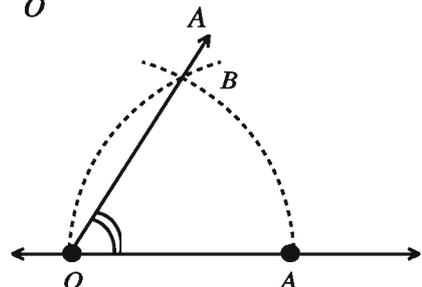

Activity

1. Draw the angles 45° , 30° , 120° without using the protractor.

Exercise 7

- What is the measure of the supplementary angle of 28° ?
 (a) 62° (b) 118° (c) 152° (d) 332°
- What is the measure of the vertically opposite angle of 37° ?
 (a) 53° (b) 37° (c) 127° (d) 143°
- What is the sum of two angles complementary to each other?
 (a) 360° (b) 180° (c) 90° (d) 80°
- If one of the three angles of a triangle is 45° , what will be another greater angle?
 (a) 360° (b) 180° (c) 90° (d) 80°
- In case of construction –
 (i) What is given is called theorem
 (ii) What is to do is drawing
 (iii) To construct logically is proof

Which one is correct?

- (a) i and ii (b) i and iii (c) ii and iii (d) i, ii and iii

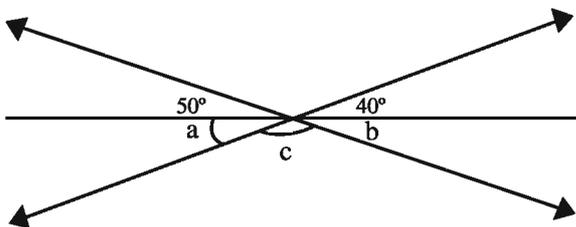

Answer questions 6-8 in the list of the above figure.

- $\angle a = ?$
 (a) 30° (b) 40° (c) 50° (d) 90°
- $\angle a + \angle b = ?$
 (a) 40° (b) 50° (c) 60° (d) 90°

8. $\angle c = ?$
 (a) 90° (b) 130° (c) 160° (d) 180°
9. With the help a protractor-
 (i) 45° angle can be drawn (ii) 155° angle can be drawn
 (iii) a circle
 Which one is the correct answer?
 (a) i and ii (b) i and iii (c) ii and iii (d) i, ii and iii

10. Use a ruler to draw a line segment of a length of 8 cm. Use the ruler and the compass to make a copy of this line segment.
11. Draw a line segment of a length of 6 cm by a ruler. Use the ruler and the compass to bisect this line segment. Measure the length of the segments and verify whether they are equal.
12. Use a ruler to draw a line segment of a length of 8 cm. Use the ruler and the compass to divide the line segment into four equal parts
13. Using a ruler and a compass draw a perpendicular bisector of a line segment of a length of 7 cm.
14. Draw perpendicular bisector of a line segment of a length of 8 cm.
15. Draw a perpendicular CD at a point C on a line AB . Again, take any other point E on CD and draw a perpendicular at E .
16. Draw the angle 45° without using a protractor.
17. Draw the bisectors of the three angles of the triangle ABC and identify their common point of intersections.

18. In the adjacent diagram
 (a) What is the supplementary angle of $\angle ABC$?
 (b) What is the measure of $\angle ACB$ and why?
 (c) Prove that $\angle DCE + \angle ECB = 180^\circ$

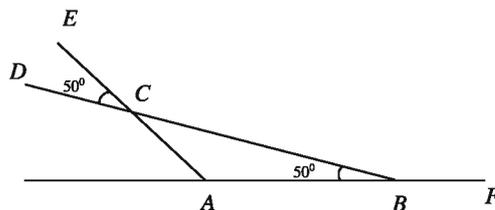

19. In the adjacent diagram

- (a) What is the vertically opposite angle of $\angle AOB$?
- (b) Bisect $\angle AOB$ and indicate the common side of the two adjacent angles.
- (c) Prove that the bisector of $\angle AOB$ and $\angle COD$ lies on the same straight line.

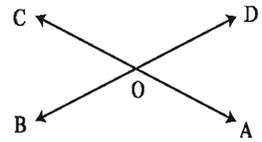

20. In the figure, $\angle ABC = 90^\circ$

- (a) Express the sum of three angles in terms of x .
- (b) Bisect the $\angle ABC$ and describe the drawing.
- (c) Draw an angle equal to the angle x and give its description.

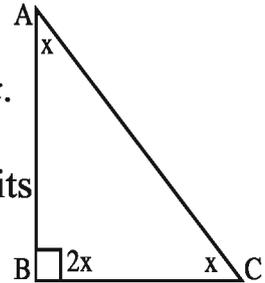

Chapter Eight

Information and Data

In our daily life, we come across the number based information and data and use them. That is why the present time is called the age of information technology. So, living in the era of information technology, it is important and essential for the students to know and acquire knowledge of information technology. Considering the facts and demand of the time, the contents regarding information, data, arithmetic mean, median and mode of the data and their use have been presented in this chapter. Special emphasis has been given on their practical use. As a result, the students will be able to use the acquired knowledge in working life.

At the end of the chapter, the students will be able to

- explain information and data.
- determine the mean, median and mode of unarranged data without classification.
- draw line diagram.
- describe the drawn line diagram.

8.1 Information

In this world of information, we often come across the information and see wide use of them. Teachers maintain attendance of the students everyday. They also maintain the records of the students' results at the end of each examination and based on which identify the weaknesses of the students and take necessary steps to remove those weaknesses. Besides, we get various information of weather, sports, market price etc. through mass media like newspaper, radio, television etc.

In a school, the marks of 10 students of class VI who have got more than 60 marks and 10 students who have got less than 60 marks in Math. are placed in the table below :

Obtained number	Number of students
90	1
80	2
75	4
70	3

Table of getting more than 60 marks

Obtained number	Number of Students
50	2
45	3
40	3
35	2

Table of getting less than 60 marks

From these comparative tables, on analysing the reasons of getting lower marks necessary measures can be adopted. Hence, the students should have clear idea how to collect and use the number based information.

The numbers, highest and lowest which have been placed in the table, are the number based information.

Each of the number based information placed in the table above is a statistics i.e. the marks 90, 80, 75, 70 obtained by the students are statistics.

Similarly, the obtained marks 50, 45, 40, 35 also form another statistics.

Data : One of the number based information of statistics is obtained highest marks. These are the data of statistics. Similarly, the information of the lowest marks is also data of statistics. The numbers used in expressing and presenting the information of statistics are data of statistics. But only one number expressing the data is not statistics. For example, age of Roni is 45 years is not statistics.

8.2 Organized and unorganized data

Let us suppose that the weights in kgs of 20 students of some school are as follows : 50, 40, 45, 47, 50, 42, 44, 40, 50, 55, 44, 55, 50, 45, 40, 45, 47, 52, 55, 56. Here, the numbers presented are unorganized. These data are called unorganized data. It is very difficult to draw a need based conclusion for such unorganized data. But if the data

are arranged in ascending or descending order necessary conclusion can be taken very easily. The collected data, if arranged in ascending order, will be 40, 40, 40, 42, 44, 44, 45, 45, 45, 47, 47, 50, 50, 50, 50, 52, 55, 55, 55, 56. Such arranged data are called organized data.

Example 1. Statistics of the tallest 10 students in centimetres studying in class VI are 125, 135, 130, 138, 137, 142, 145, 152, 150, 140.

- (a) Organize the data described above
- (b) Put the described data in tabular form

Solution : (a) The data organized in ascending order will be 125, 130, 135, 137, 138, 140, 142, 145, 150, 152.

(b) **Table**

Serial number of Students	Height in cm.	Serial number of Students	Height in cm.
1	125	6	140
2	130	7	142
3	135	8	145
4	137	9	150
5	138	10	152

Activity :

1. Form 2/3 groups consisting of 20 students studying in your class and collect secured marks in mathematics and organize them.
2. Put the organized data in tabular form.

Example 2. The bowling statistics of 5 bowlers of the cricket team are shown below in tabular form.

Sl. No.	Name	Over	Maiden over	Run given	Wicket taken
1	Sakib	5	1	35	2
2	Mashrafi	5	2	32	3
3	Razzaque	4	1	40	1
4	Ashraful	3	0	35	0
5	Moni	5	3	30	1

Activity :

- Put the following information of two score boards of a cricket game in tabular form
 - The name of 5 bowlers, overs, maiden overs, run given, wicket taken
 - The name of 5 batsmen, run, ball faced, duration of batting.
- Collect the number based information of heights, weights and secured marks of any 10 students of your class and organize them and put the organized data in tabular form.

8.3 Mean

The requirement of rice of a family in a year is 420 kgs. The requirement is not the same for all the months. The requirement varies from month to month. To know the exact requirements for all the months, it is kept in writing which is cumbersome. To avoid this, we want to know the average requirement of rice and ask how much rice is required on an average in a month. The answer is very simple, $(420 \div 12 = 35)$ and we can say the average requirement of rice in a month is 35 kgs. Here, the average requirement of rice is determined by dividing the quantity of rice by the number of months. Thus average is widely used in our day to day life. For example, the students of your class do not come to school everyday. The attendance

increases on some days and decreases on some other days. That is why, we want to know the average attendance of the students.

Mean : Mean is obtained from the sum of the collected data divided by the number of data i.e.

$$\text{Mean} = \frac{\text{The sum of the data}}{\text{The number of data}}$$

Example 3. Out of 25, the marks secured by 10 contestants in a competitive examination in Mathematics are 20, 16, 24, 16, 16, 20, 15, 12, 16, 15. Find the mean of the numbers secured by the contestants.

Solution : Mean of secured marks

$$= \frac{20 + 16 + 24 + 16 + 16 + 20 + 15 + 12 + 16 + 15}{10} = \frac{170}{10} \text{ or } 17$$

\therefore Required mean of secured marks is 17.

We use in many ways the mean of different statistics. For example, Risha, in 5 consecutive days, reads 3 hours, 4 hours, 5 hours, 2 hours and 6 hours. If she is asked by Shetu how long she reads in a day, in reply which time of what day will she say? That is why, it will be justified to

say that on an average she reads $\frac{3 + 4 + 5 + 2 + 6}{5}$ hours or 4 hours in

each of the 5 days. The average which we use, is arithmetic mean. That is why, the arithmetic mean of Risha's reading time is $\frac{3 + 4 + 5 + 2 + 6}{5}$

hours = $\frac{20}{5}$ hours = 4 hours. Hence, arithmetic mean of reading time is 4 hours.

Activity :

1. 15 books have been purchased at Tk. 1500 for your class from the book fair of 21st Feb. What is the average price of each book?
2. Measure the height (in cm.) of 10 students of your class and find the average height.

8.4 Median

In many cases the conclusion taken about the characteristics of the collected data does not have any touch with the reality. For example, the marks secured by 5 students are 40, 40, 50, 90, 100. The mean of these marks is 64. But these marks do not have touch with the reality. Median is the value of the middle of the collected data. In such cases, median is used. The median of the given data is 50. If the given data is arranged in order (in ascending or descending), the value which divides the data in two equal parts is called Median.

Such as, what is the median of the numbers 10, 9, 12, 6, 15, 7, 8, 14, 13? If the number is arranged in order, we get,

6, 7, 8, 9	10	12, 13, 14, 15
------------	----	----------------

.

It is observed that there are in total 9 numbers here and their median is 10 which is the 5th term in the ascending order.

Hence, median = $\frac{9+1}{2}$ th or 5th term.

\therefore Median = $\frac{\text{number of numbers} + 1}{2}$, if the number of data is odd.

Hence, the term of the middle of arranged order will be median if the data is of an odd number.

Now, what will be the median if the number of data is even? Let us observe the following example :

The numbers 6, 4, 7, 8, 5, 12, 10, 11, 14, 15, if arranged in order to find the median, will be 4, 5, 6, 7, 8, 10, 11, 12, 14, 15. If the numbers are divided in two equal parts, we get,

4, 5, 6, 7, 8	10, 11, 12, 14, 15
---------------	--------------------

In this case, there are 5 numbers in each part. So, what is median? We divide the numbers into two parts for finding the median in the following way :

4, 5, 6, 7	8, 10	11, 12, 14, 15
------------	-------	----------------

Hence, median will be the mean of 8 and 10. Here, the number of numbers is 10 which is an even number and the number of numbers on the left and the right of 5th and 6th terms are equal.

$$\text{Hence, median} = \frac{\text{The sum of 5th and 6th terms}}{2}$$

$$\therefore \text{Median} = \frac{8+10}{2} = \frac{18}{2} = 9.$$

Activity :

1. Form groups of 11 from your class. Find the median of the marks secured in Bangla in the class test by the members of respective groups.
2. Form groups of 12 and find the median of the data obtained from measuring the heights of the members.

8.5 Mode

Secured marks in Mathematics of 10 students of class VI of a school are 85, 80, 95, 90, 95, 87, 95, 90, 95, 100. The numbers, if arranged in ascending order are 80, 85, 87, 90, 90, 95, 95, 95, 95, 100.

Here, 90 repeats twice, 95 repeats 4 times and the rest appears only once. Again, 95 appears frequently and repeats maximum 4 times. Hence 95 is the mode of the data. Thus, the mode of data under consideration will be the number or numbers which repeat frequently and appear maximum times. Again, among the numbers 3, 6, 8, 1 and 9 no number occurs more than once. So, there is no mode here.

Example 4. The secured marks of 20 students of class VI in English of a school are as follows :

75, 60, 71, 60, 80, 78, 90, 75, 80, 92, 80, 90, 95, 90, 85, 90, 78, 75, 90, 85. Find the mode of them.

Solution : The numbers arranged in ascending order are 60, 60, 71, 75, 75, 75, 78, 78, 80, 80, 80, 85, 85, 90, 90, 90, 90, 92, 95.

Here, the frequency of repetitions of the numbers 60 is three times, 75 three times, 78 two times, 80 three times, 85 two times, 90 five times, and appearance of the rest is one time. 90 repeats the maximum number of times. Hence, the mode of the number is 90.

Activity :

Measure the heights in centimetre of all the students of your class and arrange them in order and then find the mode.

8.6 Line Diagram

The importance and use of information and data in day to day life has been already discussed. To put the data in tabular form has also been discussed. Now, the line diagram of the data will be focused for discussion. The data are widely used in line diagram. If the data are presented by graph, they become attractive and easy to understand. Such as, the runs secured in every over of a cricket game are presented in bar diagram for easy observation. Thus, the data are presented through different kinds of graphs. Here, only the line diagram will be placed for discussion.

Example 5. The heights (in centimetres) of 6 students reading in class VI of a school are 140, 145, 150, 160, 150, 165. Draw a line diagram of these data.

Solution : Two mutually perpendicular lines are drawn in a graph paper. We know that the horizontal line is x-axis and the line perpendicular to x-axis is y-axis. They intersect at the point 0. The line diagram has been drawn where two units of graph paper along x-axis represent student and one unit of graph paper along y-axis represents the heights of the students. The heights along y-axis have started from 140. The broken line along y-axis represents the omitted heights from 0 to 140.

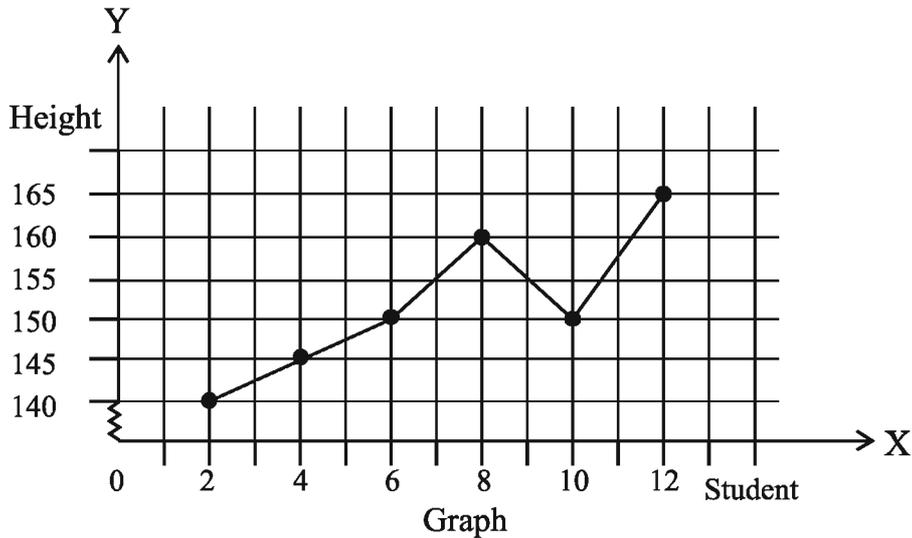

Example 6. Tandra Chakma has been hospitalised. The following line diagram has shown the temperature of one day at an interval of 3 hours. What do we understand from the line diagram ?

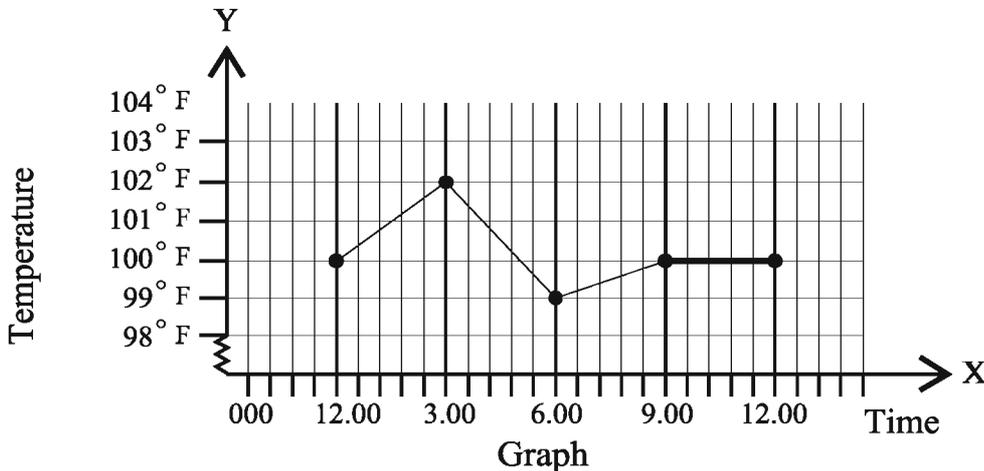

Solution : In the graph paper, x-axis represents the time interval and y-axis represents the temperature. Five units of graph paper along x-axis have been taken to represent the time at an interval of 3 hours from 12 at noon to 12 at night and each unit of graph paper along y-axis has been taken to represent the temperature.

The temperature as per time interval has been indicated in the graph paper by a dot. The data have been joined by line segments, to complete the line diagram. The normal temperature of human body is considered to be about 98° F. That is why the temperature below 98° along y-axis has been kept omitted.

It is understood from the line diagram of the temperature that the temperature is maximum 102° F at 3 pm. The temperatures remain the same at 9 pm and 12 at night which is 100° F.

Example 7 : The data of runs of Bangladesh Cricket team in a match for each over are given in the following table:

Over	1st	2nd	3rd	4th	5th	6th	7th	8th	9th	10th
Run	8	10	6	5	0	8	6	4	7	12

- Determine the difference between the highest and the lowest runs for each over.
- Determine the mean runs by arranging them per over in order of their values.
- Draw a line diagram of the given data.

Solution :

- a. The highest run: 12

and the lowest run: 0

The difference between the highest and lowest run $(12-0) = 12$

- b. Arranging the runs per over in ascending order, we get

0, 4, 5, 6, 6, 7, 8, 8, 10, 12

The sum of the runs = $0+4+5+6+6+7+8+8+10+12$
 $= 66$ runs

$$\text{Mean run per over} = \frac{\text{Total run}}{\text{Total over}} = \frac{66}{10}$$

$$= 6.6$$

(c) In the graph paper, two mutually perpendicular straight lines are drawn. We know, the horizontal line represents x-axis and the line perpendicular to x-axis is y-axis. They intersect at the point 0. The line diagram has been drawn where five units of graph paper along x-axis represent overs and two units along y-axis represent runs.

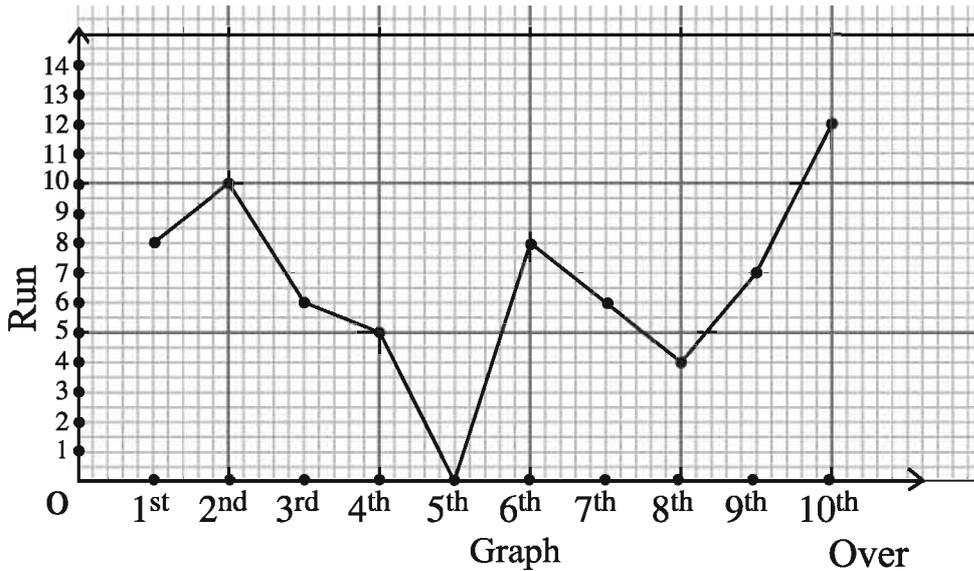

Activity : Make a problem similar to the example 7 and solve it.

Exercise 8

Put tick (\surd) mark in the correct answer :

- What is the median of the numbers 4, 6, 7, 9, 12 ?
 (a) 7 (b) 6 (c) 9 (d) 12
- Which one of the numbers 8, 9, 10, 12, 14, 16 is the median?
 (a) 9 (b) 11 (c) 16 (d) 14
- Which one of the numbers 4, 5, 8, 6, 7, 12 is the mode?
 (a) 6 (b) 7 (c) 12 (d) no mode
- Which one of the numbers 8, 12, 11, 12, 14, 18 is the mode?
 (a) 8 (b) 11 (c) 12 (d) 18

5. If the number of data is even, which of the following is median?
(a) the mean of two middle terms (b) the sum of two middle terms
(c) the mean of the last two terms (d) the sum of first two terms.
6. What type of data are 48, 22, 28, 25, 15 ?
(a) organised (b) unorganized
(c) arranged in ascending order (d) arranged in descending order
7. Which of the following data are organised?
(a) 8, 6, 0, 4 (b) 2, 4, 2, 4
(c) 8, 6, 4, 2 (d) 2, 4, 8, 0
8. Of data 6, 12, 22, 22, 26, 30, 36 ?
(i) mode 22
(ii) median 22
(iii) mean, median and mode are equal to each other.

Which one is correct?

- (a) i and ii (b) i and iii
(c) ii and iii (d) i, ii and iii

Answer questions 9-12 using the following information.

The obtained results of 6 students out of 20 marks: 8, 10, 16, 14, 16, 20.

9. What is the mode of the data?
(a) 8 (b) 14
(c) 16 (d) 20
10. What is the median?
(a) 14 (b) 15
(c) 16 (d) 30

11. What is the mean?
(a) 13.6 (b) 14
(c) 16 (d) 16.8
12. The actual information of the data is—
(i) the highest number is 16
(ii) the difference between the highest and the lowest number is 12
(iii) the lowest number scored in the examination is 40%
Which one is correct?
(a) i and ii (b) i and iii
(c) ii and iii (d) i, ii and iii
13. What are data and information? Present with examples.
14. The weight of Kalam is 50 kg. The average weight of students of class VI is 50 kg. Which one of these two information is statistics ?
Explain.
15. The secured marks in Mathematics of 20 students of your class are : 30, 40, 35, 50, 60, 70, 65, 75, 60, 70, 60, 30, 40, 80, 75, 90, 100, 95, 90, 85.
(a) Are these organized data ?
(b) If the data are unorganized, organize it.
(c) Arrange the data in ascending and descending orders.
(d) Find the arithmetic mean.
16. Measure and present the weights of 15 students of your class and find the mean.
17. Find the median of the following data
9, 12, 10, 6, 15, 8, 7, 14, 13.

18. Find the median of the following data :
1400, 2500, 1500, 700, 600, 900, 1050, 1100, 800, 1200.
19. Find the median of the data 9, 16, 14, 22, 17, 20, 11, 7, 19, 12, 21.
20. Find the median of the numbers 5, 7, 12, 10, 9, 19, 13, 15, 16, 24, 21, 23, 25, 11, 14, 20.
21. The numerical values of some data 4,5,6,7,8,9,11,12. Find their mode.
22. Find the mode of the data of the numerical values 3, 4, 6, 7, 8, 9, 10, 11.
23. Followings are the weekly savings (in taka) of 38 labours :
155, 165, 173, 143, 168, 146, 156, 162, 158, 148, 159, 147, 150, 136, 132, 156, 140, 155, 145, 135, 151, 141, 169, 140, 125, 122, 140, 137, 145, 150, 164, 142, 156, 152, 146, 148, 157 and 167.
 - (a) Arrange the data in order, put them in tabular form and find the mean.
 - (b) Find the median and mode.
24. Draw a line diagram of temperature (Ferenhite) of Shuzon at an interval of 3 hours starting from 6 a.m. for 12 hours.
 - (a) Why the temperature from 0° to 98° is generally excluded in the axis?
 - (b) Describe the nature of the temperature during 12 hours of time.
25. A students writes the following numbers taking from 20 to 40.
21,37,40,22,39,35,22,25,32,22,21,37,40,22,39,35,25,22,37,39,32,22, 37,32, 40,37,22,35,22
 - a. Write down the given numbers in order of their values.
 - b. Determine the median and the mode of the data.
 - c. Draw the line graph of the given data.

Answer

Exercise 1.1

- 1 to 3. Do yourself 4. 999999999 ; 100000000 5.(a) 9854321;
1234589 (b) 9875430 ; 3045789 6. 7999996 ; 7000006
7. Fifty five thousand four hundred thirty seven.

Exercise 1.2

1. 31, 37, 41, 43, 47, 53, 59, 61, 67.
2. (d) 3. (a) 6774, 8535 (b) 2184 (c) 2184, 1074 (d) 1737
4. (a) 6 (b) 5 (c) 2 (d) 0, 9 5. 10002 6. 9999996
7. divisible by 4 and 5

Exercise 1.3

1. (a) 12 (b) 15 (c) 1 2. (a) 15 (b) 11 3. (a) 150 (b) 792 (c) 864
4. (a) 480 (b) 3185 (c) 7920 5. 12 6. 12 7. 77 8. 3595
9. 96 cm, iron-sheet 7 pieces, copper-sheet 10 pieces.
10. 1260 11. 99370 12. 480 km 13. 260

Exercise 1.4

1. (a) equivalent (b) not equivalent (c) equivalent
2. (a) $\frac{16}{40}, \frac{28}{40}, \frac{9}{40}$ (b) $\frac{408}{600}, \frac{345}{600}, \frac{335}{600}$ 3. (a) $\frac{16}{21}, \frac{7}{9}, \frac{50}{63}, \frac{6}{7}$
(b) $\frac{17}{24}, \frac{31}{36}, \frac{53}{60}, \frac{65}{72}$
4. (a) $\frac{7}{8}, \frac{6}{7}, \frac{3}{4}, \frac{5}{12}$ (b) $\frac{51}{65}, \frac{17}{25}, \frac{23}{40}, \frac{67}{130}$ 5. (a) $\frac{13}{16}$ (b) $7\frac{6}{7}$
(c) $20\frac{17}{26}$ (d) 190 m 54 $\frac{3}{25}$ cm 6. (a) $\frac{13}{56}$ (b) $\frac{44}{45}$ (c) $10\frac{1}{21}$
(d) 8 kg $2\frac{23}{25}$ gm

7. (a) $14\frac{3}{56}$ (b) $2\frac{15}{32}$ (c) $4\frac{11}{30}$ 8. $60\frac{17}{100}$ 9. $8\frac{29}{100}$ m 10. $195\frac{7}{10}$ cm

Exercise 1.5

1. (a) 4 (b) $15\frac{39}{64}$ (c) $3\frac{3}{34}$ 2. (a) $5\frac{1}{3}$ (b) $\frac{117}{592}$ (c) $1\frac{7}{8}$ 3. (a) 3 (b) $13\frac{4}{9}$

(c) $1\frac{7}{20}$; 4. (a) $\frac{5}{6}$ (b) $\frac{2}{5}$ (c) $\frac{1}{60}$; 5. (a) $15\frac{3}{4}$

(b) 60 (c) $14\frac{2}{5}$; 6. $\frac{35}{324}$ portion

7. $34\frac{2}{9}$; 8. $1\frac{1}{2}$ kg 10. $\frac{41}{54}$ 11. $2\frac{1}{4}$ 12. 1 13. $1\frac{2}{3}$ 14. $1\frac{1}{2}$ 15. $7\frac{1}{2}$

Exercise 1.6

12. (a) 4·183 (b) 116.616 13. (a) 92·125 (b) 1·4742 (c) 875·013

14. (a) 0·654 (b) 0·001188 (c) 75·4 (d) 0·000000105 15. (a) 0·39

(b) 7900 (c) 13·44 16. 14 17. Tk. 21·75 18. 28·55

19. 21·59 cm 20. 7 hour 21.11 22.20 m 23. Tk. 14, 40, 000.00

Exercise 2.1

1. (a) 5 : 7, (b) 110 : 141, (c) 2 : 1, (d) 70 : 23, (e) 5 : 1

2. (a) 3 : 4, (b) 5 : 7, (c) 5 : 4, (d) 5 : 2 3. (a) 12, (b) 30, (c) 9, (d) 7

4.

breadth of hall room(m)	10	20	40	80	160
length of hall room (m)	25	50	100	200	400

5. 12 : 18 ; 6 : 9 ; 2 : 3 are equivalent fractions

6 : 18 ; 2 : 6 ; 1 : 3 are equivalent fractions

15 : 10 ; 3 : 2 ; 12 : 8 are equivalent fractions

6. (a) 1 : 3, (b) 3 : 1, 7. 16 : 9, 8. (c)

9. Tk. 250 and Tk. 300 ; Again, Tk. 200 and Tk. 350

10. 12 years, 11. 300 and 330, 12. Tk. 60
 13. The amount of gold is 15 gm, and the amount of alloy is 5 gm
 14. $7\frac{1}{2}$ km 15. 14 kg 16. Tk. 30000 and 1 : 1 unit ratio

Exercise 2.2

1. (a) 75%, (b) $46\frac{2}{3}\%$, (c) 80%, (d) 224%, (e) 25%, (f) 65%, (g) 250%,
 (h) 30%, (i) 48% 2. (a) $\frac{9}{20}$ and 0.45, (b) $\frac{1}{8}$, 0.125, (c) $\frac{3}{8}$, 0.375
 (d) $\frac{9}{80}$, 0.1125 3. (a) $6\frac{1}{4}$, (b) $20\frac{1}{4}$, (c) $\frac{9}{25}$ kg., (d) 80 cm.
 4. (a) 25%, (b) $62\frac{1}{2}\%$, 5. 300 persons, 6. $66\frac{2}{3}\%$, 3 : 2, 7. 30%,
 8. 60%, 9. 10%, 10. 840 persons 11. 190 persons, 12. Tk. 200

Exercise 2.3

15. Tk. 600 16. 30 day 17. Tk. 12000 18. 200 kg
 19. $22\frac{1}{2}$ day 20. 36 persons 21. 9 days
 22. 140 persons 23. 20 days 24. 60 km, 5 km /hour 25. 10 days
 26. 12 hours 27. 7 days 28. 14 days

Exercise 3.1

Do yourself

Exercise 3.2

1. (a) 3, (b) -6, (c) -8, (d) 5 2. (a) 4, (b) 5, (c) 9, (d) -6, (e) 2
 3. (a) 102, (b) 0, (c) 27, (d) 50 4. (a) 4, (b) -38

Exercise 3.3

10. (a) 15, (b) -18, (c) 3, (d) -33, (e) 35, (f) 8
 11. (a) <, (b) >, (c) >, (d) >
 12. (a) 8, (b) -3, (c) 0, (d) -8, (e) 5
 13. (b) 10, (b) 10, (c) -105, (d) 92

Exercise 4.1

1. (i) 9 times of x (ii) addition of 3 with 5 times of x
 (iii) addition of 4 times of b with 3 times of a
 (iv) product of 3 times of a , 4 times of b and c
 (v) Half of the sum of 4 times of x and 5 times of y
 (vi) One-fourth of the difference of 3 times of y times of 7 times of x
 (vii) Subtraction of 2 divided by 5 from the sum of the quotients obtained by dividing x by 3 and y by 2.
 (viii) Addition of 7 times z with the difference obtained by subtracting 5 times of y from twice of x .
 (ix) Two-third of the sum of x, y and z .
 (x) One-seventh of the subtraction of the product of b and x from the product of a and c .
2. (i) $4x + 5y$ (ii) $2a - b$ (iii) $3x + 2y$, where the first number is x and another is y (iv) $4x - 3y$ (v) $\frac{a-b}{a+b}$ (vi) $\frac{x}{y} + 5$
 (vii) $\frac{2}{x} + \frac{5}{y} + \frac{3}{z}$ (viii) $\frac{a}{b} + 3$ (ix) $pq + r$ (x) $xy - 7$
3. Three times ; $2x, 3y \div 4x$ and $5x \times 8y$ 4. (i) 1 (ii) 2 (iii) 3
 (iv) 3 (v) 3
5. (a) (i) 6 (ii) 1 (iii) 7 (iv) 2 and 5 (v) 2 and 8
 (vi) 14 and -4 (vii) $-\frac{1}{2}$
 (b) (i) a (ii) a (iii) a (iv) py
6. (i) Price of 3 books (ii) Price of 7 pens (iii) Price of 1 pen and 9 books together
 (iv) Price of 5 pens and 8 books together (v) Price of 6 books and 3 pens together.
7. (a) (i) Tk. $(5x + 6y)$ (ii) Tk. $(8y + 3z)$ (iii) Tk. $10x + 5y + 2z$
 (b) (i) Tk. $5x$ (ii) Tk. $3x$ 8. (i) (b) (ii) (a) (iii) (c)

Exercise 4.2

1. (i) x^{10} (ii) a^9 (iii) x^{15} (iv) m^6n^{10} (v) $360a^2b^2c$ (vi) $48x^4y^4z^2$
 2. (i) 17 (ii) 28 (iii) -4 (iv) 1 (v) 1
 4. (i) (b) (ii) (c) (iii) (b) (iv) (c) (v) (d)

Exercise 4.3

1. (d) 2. (b) 3. (b) 4. (c) 5. (d) 6. (c) 7. (b) 8. (b) 9. (a) 10. (b) 11. (a)
 12. (b) 13. (c) 14-(1). (d) 14-(2). (c) 15-(1). (a) 15(2). (b) 15(3).
 (c) 15(4). (b). 16. $4a + 7b$ 17. $10a + 14b$ 18. $3a + b$ 19. $x + 3y + 10z$
 20. $6x^2 + 6xy + 2z$ 21. $-2p^2 + 15q^2 + 6r^2$ 22. $a + 5b + c$ 23. $-x + 3$
 24. $ax - 2by - 3cz$ 25. $5x$ 28. $-2a - 2b + 3c$ 29. $ab + 10bc - 10ca$
 30. $2a^2 + 2c^2$ 31. $ax - by - 3cz$ 32. $-x^2 + 4x + 9$
 33. $4x^3y^2 - 6x^2y^2 + 2xy$ 34. $x^2 + 5y^2 + 2z$ 35. $x^4 + x^3 + 3x^2 - 2x + 1$.
 39. 1. (a) 1 (b) $2a^2 + 3c^2$ (c) $3a^2 - 2b^2 + 4c^2$ 40. (a) Tk. $(3x + 2y)$
 (b) $(5x + 8z) - 10y$
 (c) Addition of the price of 5 pencils with the difference of the price
 of 2 pens form the price of 3 khata ; -2 and 5 ; -2 and 5 ; -30
 41. (a) Three ; $5x^2, xy$ and $3y^2$ (b) $5x^2 + 3xy + 4y^2, 3$ (c) 20

Exercise 5

1. b. 2. a. 3. d. 4.d. 5.a. 6.a 7.d. 8.d. 9.b 10. c. 11. (1) b. 11. (2) b. 11.
 (3) c. 12. 9 13.4 14.9 15.16 16. 12 17.4 18. 4 19. 4 20. $\frac{22}{3}$
 21. 3 22. -11 23. -3 24. 4 25.16 26. 3 27. 5 28. 4 29. 12
 30. 12 31. 5 32. 14,16 33. 7,9,11 34. a. $2(x + x + 2)$ b. 8 metre c.
 Tk. 4 35. a. $x + 1, x + 2$ b. 7, 8, 9 c. 10

Exercise 8

1. (a) 2. (b) 3. (d) 4. (c) 5.(a) 6. (b) 7. (c) 8. (d) 9.(c) 10.(b)
 11.(b) 12.(c) 15. (d) 65 17.10 18. 1075 19. 16 20. 14.5 21. 8
 22. none 23. (a) Tk. 149.5
 (b) Median Tk. 149 and Mode Tk. 156

The End

2019

Academic Year

6-Math

সমৃদ্ধ বাংলাদেশ গড়ে তোলার জন্য যোগ্যতা অর্জন কর

– মাননীয় প্রধানমন্ত্রী শেখ হাসিনা

জীবে দয়া কর

নারী ও শিশু নির্যাতনের ঘটনা ঘটলে প্রতিকার ও প্রতিরোধের জন্য ন্যাশনাল হেল্পলাইন সেন্টারে
১০৯ নম্বর-এ (টোল ফ্রি, ২৪ ঘণ্টা সার্ভিস) ফোন করুন



Ministry of Education

For free distribution from academic year 2010 by the Government of the
People's Republic of Bangladesh