

# Arts and Crafts

## Class Seven



NATIONAL CURRICULUM AND TEXTBOOK BOARD, BANGLADESH

**Prescribed by the National Curriculum and Textbook Board  
as a Textbook for class seven from the academic year 2013**

---

# **Arts and Crafts**

## **Class Seven**

### **Written by**

Hashem khan

Adeline Malakar

A.S.M. Atiqul Islam

Sanjib Das

### **Edited by**

Mustafa Monowar

### **Translated by**

Asaduzzaman

Ziaul Abedin Rakhal

**Published by**  
**National Curriculum and Textbook Board**  
69-70, Motijheel Commercial Area, Dhaka

---

[All rights reserved by the publisher]

**First Edition** : December, 2012  
**Revised Edition** : July, 2015  
**Reprint** : August, 2018

**Design**

National Curriculum and Textbook Board, Bangladesh

For free distribution by the Government of the People's Republic of Bangladesh  
Printed by :

## Preface

The aim of secondary education is to make the learners fit for entry into higher education by flourishing their latent talents and prospects with a view to building the nation with the spirit of the Language Movement and the Liberation War. To make the learners skilled and competent citizens of the country based on the economic, social, cultural and environmental settings is also an important issue of secondary education.

The textbooks of secondary level have been written and compiled according to the revised curriculum 2012 in accordance with the aims and objectives of National Education Policy-2010. Contents and presentations of the textbooks have been selected according to the moral and humanistic values of Bengali tradition and culture and the spirit of Liberation War 1971 ensuring equal dignity for all irrespective of caste and creed of different religions and sex.

The present government is committed to ensure the successful implementation of Vision 2021. Honorable Prime Minister, Government of the People's Republic of Bangladesh, Sheikh Hasina expressed her firm determination to make the country free from illiteracy and instructed the concerned authority to give free textbooks to every student of the country. National Curriculum and Textbook Board started to distribute textbooks free of cost since 2010 according to her instruction.

**Arts and Crafts** increases observation ability about nature, environment, life and life-style. This subject also helps to understand other subjects. For example, this subject helps acquiring applied knowledge and efficiency of General Science, Geography, Medical Science, Engineering Science, Architecture etc. By learning this art, sense of discipline, sense of proportion, aestheticism, patriotism and human values will develop and grow in the learners and they will become creative. Hopefully, objectives of the new curriculum have been properly reflected in 'Arts and Crafts' textbook.

I thank sincerely all for their intellectual labor who were involved in the process of revision, writing, editing, art and design of the textbook.

**Prof. Narayan Chandra Saha**  
Chairman

National Curriculum and Textbook Board, Bangladesh.



## CONTENTS

<b>Chapter</b>	<b>Title</b>	<b>Pages</b>
One	The History of Fine Arts Education of Bangladesh	1-8
Two	Fine Arts is the language of all people of all ages	9-17
Three	The Folk Art and Handicrafts of Bangladesh	18-28
Four	Different media of drawing Pictures	29-33
Five	Various interesting practices of drawing pictures	34-42
Six	Different types of Crafts	43-60
	Colors and their uses	61-68

# **Chapter One**

## **The History of Fine Arts Education of Bangladesh**



**Faculty of Fine Arts, Dhaka University**

**After we have studied this chapter, we will be able to**

- describe the brief history of fine arts and crafts education in Bangladesh.
- mention the names of pioneering artists of teaching fine arts in Bangladesh.
- explain the necessity of learning fine arts in the society.

## Lesson: 1

Those who draw or paint pictures are artists or painters. Those who sing are singers. Actors and actresses are known as theatre artists or cinema artists. Those who perform dances are known as dancers. This is how every division or subject of cultural practice has some sort of unique identity.



Shilpacharya Zainul Abedin is drawing a picture

Every sphere of art and culture needs practice and exercise. It doesn't matter whether someone is old or young in age; the practice of fine arts can be started at any age. However, to practice in the institutional manner, one has to follow some simple rules and regulations.

If we take the example of singing, we find that one has to understand rhythm, melody and musical notes. Starting from the seven notes of sargam one has to learn some other notes, melody and music. This needs everyday practice which the singers term as reowaz or practice of music. A singer has to continue this practice throughout his or her life. The famous artists in the sphere of singing always keep to this rule with much importance.

It is also important to draw pictures regularly when someone is in the fine arts. However, the case of painting or drawing is different from singing in this sense that one doesn't need to learn all the rules and regulations of drawing pictures at the very beginning. In singing, one has to learn the notes, melody and other basics from one's childhood but for painting it's not necessary. Rather, a child should be encouraged to follow his or her own will and imagination so that he or she may have confidence in depicting his or her dreams, thoughts and wishes. This naturalness is given much importance in the case of drawing pictures. It is never wise to forcefully instruct a child to draw or paint pictures. Children and youngsters should draw pictures according to their will till a certain age. When a child finds joy in drawing pictures, he or she can draw wonderful pieces.

Generally it is good to start drawing pictures by following rules and regulations when someone is in grade six. At an average, they can go on drawing pictures on their own till they finish grade five. It becomes institutional education when someone learns by following rules and regulations. Now we are going to learn about institutional education of fine arts in Bangladesh

**Task :** Write five sentences about the subjects you prefer drawing pictures.



## Lesson: 2

Before the establishment of independent Bangladesh, the institute of teaching fine arts was built in Dhaka in 1948. A number of artists took the initiative. They completed their course at Art College in Kolkata. They are *shilpacharya* Zainul Abedin, *Potua* Quamrul Hasan, Khaja Shafiq Ahmed, Shafiuddin Ahmed,



Shilpacharya Zainul Abedin

Anowarul Hoque and Shafiqul Amin. At the end of two hundred years of British rule in India in 1947, India was divided into two independent countries. One of them, was named India and the other was Pakistan. Again, Pakistan had two parts-East Pakistan and West Pakistan.



Artist Quamrul Hassan

The artists had to face huge obstacles to establish Fine Arts Institute in 1948 in Dhaka, the capital of East Pakistan. At that time 'drawing pictures' was not socially accepted. Nobody could think of earning their livelihood by drawing pictures. The question was what could be achieved by drawing pictures. There was no condition of earning by drawing pictures in the country. There was no government job as well. So, what can be achieved by drawing pictures? On the other hand, social prejudice and orthodoxy were great obstacles.

So, Shilpacharya Zainul Abedin, Quamrul Hasan, Anowarul Hoque, Shafiuddin Ahmed proposed the government that after the partition of greater India, like many other things, the people of East Pakistan had the right to get the half of Kolkata Art College. Therefore, the logic was that an Art College could be established in Dhaka very easily. Almost all these artists were the teachers of Kolkata Art College and employees of previously British ruled Indian Government.

## Lesson: 3

The then Pakistan Government refused the proposal of the artists in a very negligent manner. They showed the reason that Pakistan was an Islamic country. They argued Pakistan needed such educational institutes through which the Islamic tradition could be established everywhere and art college could not serve that purpose.

The artists did not go back. They convinced the government that artists were needed to build up the new country beautifully and to make the life of people beautiful and elegant. They mentioned some examples at that time. These are-

1. The general people have to be provided with health services and in order to recover them from different diseases, they can easily be made understand the preventive measures by making posters with pictures. It is not easy to make them understand in writing books because the number of educated people in the country is very small.
2. In publicity of different issues of the government, artists are needed to make posters and leaflets. The rules of walking on roads and running buses and trucks etc. can be disseminated through such visual presentation.
3. General mass can easily be made understood how to cultivate easily, irrigate effectively, by aware of insects and increase agricultural products. All these topics can be presented by drawing pictures.
4. Artists are urgently needed for drawing maps, pictures for books of schools and colleges, and for books of medicine and polytechnic institutes.
5. Industrialization will gradually develop in this new country. Various types of packets will have to be made to export the products in the market and abroad after production. The packets will need design and pictures. The advertisement will be made by drawing pictures.

So, artists are very important for any country, people and for welfare as well. Therefore, the government should start to build a college or institution for producing artists as soon as possible.

#### **Lesson: 4**

The artists thus showing different types of logic to the high officials of the then Pakistan government have upheld the view that the fine arts education should be established for the sake of the country. A number of educated Bangladeshi came forward praising this initiative of the artists. Scientist Dr. Kudrat E Khuda was then the chief of Directorate of Public Instruction (DPI) of the East Pakistan. He also made the government understand that fine arts education was definitely needed. High government official Solimullah Fahmi, Abul Kashem and so on stood by the artists. They tried different ways to convince the government to change their attitude and realize the necessity of fine arts. At that time, journalist and cultural minded people also started to write in the newspapers about the importance of drawing picture. They were - Dr. Sarwar Murshid, Borhan Uddin

Khan Jahangir, Munir Chowdhury, Shawkat Osman, Ajit Guh, Sikander Abu Zafor, Ohidul Hoque and so on. Because of writing and discussion, the government gradually became flexible though some people started to make adverse comments from religious point of view about the government and culture loving people. They gave religions verdict that it is sinful and non-Islamic to draw pictures in an Islamic country. But within 4/5 years of its inception the artists kept proving that religious opposition was baseless. The work that gives pleasure to people and also is used for the welfare of mankind can never be a sin. The artists can't finally convince the authority that the so-called religions explanations were the mental fabrication of some people. Fine arts learning and practice are very important for every kind of development and welfare of mankind.

**Task :** Why is drawing pictures beneficial.

### **Lesson: 5**

After a continuous effort, at last an educational institution was established for painting in Dhaka, in the capital of the then East Pakistan. The date was 15 November 1948. The first institution for painting started in two rooms of National Medical College at Nababpur. It was named the Government Art Institute. 12 students got admitted in the first year. Artist Zainul Abedin was appointed the principal. Other teachers were Anowarul Hoque, Khaja Shafiq Ahmed, Quamrul Hasan, Syed Ali Ahsan and Shafiqul Amin. They all studied at Kolkata Art College. Zainul Abedin, Anowarul Hoque and Shafiuddin Ahmed were appointed as teachers at Kolkata Art College also. At the partition of India in 1947, they came back to Dhaka. Then, after one year's of struggle, they established a similar fine art college in Dhaka. Artist Mohammad Kibria joined as a teacher after two years. He also studied at Kolkata Art College.

**Task:** Write the name of the first art institute and the name of the Principal of that institute.

### **Lesson: 6**

The pioneer artists of Fine Arts

In 1948 the introduction of learning fine arts began in Bangladesh, the then East Pakistan. Those who led the movement of learning art should be called the pioneers. This is because we can now draw pictures freely as they showed us the way. We are studying this subject because they paved the way for us. A significant

number of artists contributed much to the expansion of fine arts education after they have studied at this institution. Two of the twelve artists from the first batch established their fame as artists. One is Aminul Islam and the other is artist Syed Shafikul Hossen. Most of the remaining ten artists took painting as their profession and contributed in making the society understand the necessity of art and artists. Aminul Islam advanced the practice of art in Bangladesh. He has a great contribution to the gradual development and establishment of the fine arts for a long time in Bangladesh. Both Aminul Islam and Syed Shafikul Hossen also worked as the principal of Fine Arts Institute.

### **Lesson: 7 & 8**

Shilpacharya Zainul Abedin and the other founder artists did not give up only by establishing the Fine Art Institute. They also paid their attention to the painters so that they could use the paintings in different ways in case of necessity of the society. The teachers and students were jointly trying to mould public opinion about creating honorable posts for the painters in different institutions of the government, and other institutions etc. That effort became a cultural movement. The work was not easy at all. It took ten to twelve years to convince the state and the society that art is important like any other professions to build up a beautiful society and a successful country. As engineers, doctors, teachers, administrators, architects, actors, musicians are needed for a developed society, the artists can greatly contribute to build up a beautiful society.

So, it can be easily said that Shilpacharya Zainul Abedin had a major role establishing the fine arts in Bangladesh. Artist Anowarul Hoque, artist Shafiuddin Ahmed, Pouta Quamrul Hasan, Khaja Shafiq Ahmed, Shafiquel Amin, artist Mohammad Kibria equally struggled with them. Who came for learning art for the first 12 years also worked with their teachers with equal devotion. As a result, a characteristic and form of self perception of art of Bangladesh have been established which take the practice of fine arts of Bangladesh to the international standard. Some of those who had remarkable contribution werem Quyyum Chowdhury, Rashid Chowdhury, Murtaza Bashir, Abdur Razzak, Abdul Baset, Hamidur Rahman, Syed Jahangir, Samorjit Roy Chowdhury, Hashem Khan, Rafiqunabi, Nitun Kundu, Devdas Chatterjee, Abu Taher, Mahmudul Hoque, Monirul Islam, Abul Barok Alvi and so on.

### Sample Questions

Put tick mark (✓) at the correct option

1. Those who draw pictures are - theatre artists/ painters/ dancers.
2. Those who perform in drama and cinema are - potters/actors/ painters
3. Those who can sing wonderfully are - actors/ singers/actors of drama
4. At first, to teach the children how to draw- they are to teach the rules and regulations very well/ let them draw pictures at their sweet will.
5. Generally, it is good for the children to draw pictures-following rules and regulations gradually from class six/learning rules and regulations starting from class one.
6. The ancient men used to - draw pictures on canvas/ draw pictures on the walls of caves/ draw pictures on paper.
7. The ancient men used to collect their color and brush for painting from-shops in the town/by using soil, animal fat and sharpening stones by themselves.
8. Till fifteenth - sixteenth century the artists used to-learn drawing pictures by going to famous art colleges/ learn from the masters by helping the masters or teachers in the work of drawing pictures.
9. The Pakistan government-called the artists after establishing Art College by itself/ started the institution for learning art because of the demand of artist Zainul Abedin, Quamrul Hasan, Shafiuddin Ahmed, Anowarul Hoque, Shafiquel Amin, and so on.
10. The name of the first institution for learning art was - Government Art College/Government Art Institute.
11. The Government Art Institute started its journey on - 14 August 1947/ 15 November 1948/ 22 August 1948.
12. The own institute of learning art - the classes of the Government Art Institute began at the present Fine Art Institute of Dhaka University/ began only in two rooms of the National Medical College at Nababpur.
13. To build up a developed society artists have their roles like the engineers, doctors and scientists/artists draw pictures for themselves and for their display only.



**Questions for brief answers**

1. How can someone draw pictures in childhood and during studying at a school?
2. In which year, how and through whose efforts was the educational institution of fine arts and crafts established in present Bangladesh or the then East Pakistan? What was the first name of the institution?
3. Through which examples did the artists make the government realize the importance of establishing the Government Art Institute?
4. How many students took admission in the first year? Write about them.
5. Who are the artists that contributed in flourishing culture and fine arts education in h the first twelve years by studying art?
6. What feelings do work in your mind at the time of drawing pictures?
7. What are the importances of arts and crafts?
8. What was the contribution of the artists during Liberation War of Bangladesh?

## Chapter Two

### Fine Arts is the language of all people of all ages



*In a restaurant in Paris, to make understand what he wanted to eat the famous artist Zainal Abedin drew those things on a piece of paper. By drawing he explained whether to eat boiled or fried food. By drawing, he also said he would not drink wine.*

After we have studied this chapter, we will be able to-

- learn that before civilization people used pictures to express their feelings.
- explain how by using art or picture people all over the world can communicate well.
- describe the famous artists and their artworks.

## Lesson: 1

Starting from the primitive time from the cave age man have conquered the world in many different ways. Today man has reached a great hight starting from nowhere. Man cannot live depending only on nature. The main obstacle is the relationship among human beings. For survival and for food men had to overcome the catastrophe of nature and had to live in panic for the attack of the brutal and



The Cave of Altamira a cave picture

ferocious animals. To be free, they used to believe in magic, drew different types of pictures on the mountain walls and faced those obstacles by getting united. But why did people draw pictures! We will now know the mystery behind this.

It was the year 1879. In the northern part of Spain, a landlord named Soutula lived. His regions were large. There were many mountains. In this place he discovered a cave. He started digging the cave by thinking that he might find something valuable there. He thought might be the skeletons of primitive people and weapons made of stone. Eventually he started to look for these things. His five year old daughter was with him. Of course she did not know anything about it. She had come out by holding her father's hand on a short visit.

Entering the cave, the father started to look for skeletons and weapons. But the little girl did not like that matter. Taking a candle in her hand she started to moving around. Moving around at a point suddenly her eyes were stuck at a place. Instantly she started shouting, 'Daddy, Bull! Bull!' Hearing her shouts father came running, thinking a real bull was in the cave!

No! Not a real bull. But it was exactly like a bull. It's a picture of a bull. The discovery of the little girl became known to all. Famous scholars started to visit the cave Altamira. After that for the next sixteen years the scholars engaged themselves in discussion about the picture of the bull. They debated and also conducted researches. The first discovered picture drawn by the primitive people was twenty thousand years old. Its existence was located in the mountain caves of Spain's Altamira, France's Lamu and Lasko. Men learned art of drawing because of survival and living. They expressed their feelings by signs

and gestures. Then in 1895 a new cave was discovered in Spain. Many different types of drawing and artwork were discovered on the walls of that cave. Who drew those pictures? Obviously those people were from the primitive age. Those primitive people first started to express their thoughts by using pictures as a medium.

### Lesson: 2

Many carving in the caves by primitive people were found in the countries such as France, Spain and South Africa etc. After many calculation the scholars found that some of the pictures were probably 10,000 to 30,000 B.C old.



From this article we have come to know that people chose picture as the first medium to express their feelings.

In today's world there are many different countries, and there are different types of people and again their languages are also different. It is not possible for one person to learn all those languages. But if pictures are drawn according to the nature, environment, lifestyle of a country, one can easily grasp information about that country.

Suppose, that on the occasion of a festival, in our country, children from China, Japan and many other countries have gathered together. It is possible to exchange greetings with one another but we will not be able to talk about our country, environment, etc. because of our lack of understanding in different language. If we draw pictures related to our countries' environment, nature, life and culture, the identity and features of every country are reflected there. That is why by only

the language of picture or arts and craft, we can easily understand the culture and natural environment of any nation in this world. This is why art can be termed as the international language.

**Task:** Give your opinion in ten sentences that "Art is an international language".

### **Lesson 3**

#### **World famous artists and their artworks**

From the primitive time till today hundreds of pictures were drawn by hundreds of artists. The names of the artists of cave drawings remain unknown to us. So many paintings have been drawn by artists in many countries in later time. Some of them became world famous through their artwork. Many great artists in this sub-continent by their creations in the field of art have taken the place in the history of art and craft. Among them some of the special personalities are Rabindranath Tagore, Gogonendranath Tagore, Abonindranath Tagore, Jamini Roy, Nandalal Bose and others. Likewise, pioneer artists of our country are Shilpacharya Zainul Abedin, Quamrul Hasan, S.M.Sultan and Anowarul Haque. After them some other famous artists who continued to uphold the arts are Mohammad Kibria, Qayyum Chowdhury, Aminul Islam, Hamidur Rahman, Murtoza Bashir, Mustafa Monowar, Rashid Chowdhury, Abdur Razzak, Abdul Baset, Debdash Chatterjee, Nitun Kundu, Hashem Khan, Rafiqun Nabi, Monirul Islam and others

Let us know about the life and works of some of the artists who became famous in the world for art and sculpture.

### **Lesson 4**

#### **Leonardo Da Vinci**

Leonardo Da Vinci was born in 1452 B.C. in a small village named Anchiano, 60 miles away from Florence of Italy in a small town called Vinci. His father Piero Da Vinci was a respectable wealthy person. His mother's name was Catherine. As a child was Davinci good looking and physically healthy. His father Piero tried his

best for a bright future of his son. Leonardo Da Vinci grew up in great wealth and prosperity. Leonardo Da Vinci was born at a time when Italy was going through Renaissance.

At that time a new era of revolution had started in Europe. He had a great liking for horse riding, music, painting, medical science, and architecture. He used to have many experiments on paintings. He designed a layout of an airplane by observing the birds flying in the sky. He also dissected and experimented human dead bodies to acquire the correct knowledge of the anatomy of human body. Besides fine art, his research on other things helped science to discover and invent many things later on. He had uncountable paintings on different subjects.



Leonardo Da Vinci



Monalisa

He had done research on different topics of science. Later on from his ideas and imagination, airplane, land transport and sea ships were invented that are the wonders of modern world.

Among his works, the Mona Lisa still remains the world famous portrait. The painting is now the property of Louvre Museum. Its length is 3 feet and breadth is 2 feet. This 25 year old lady was the wife of a man named Francesco del Giocondo of Italy. The smile on her face is a mystery to us till today. Besides Mona Lisa, other famous paintings are Adoration of the Kings, Virgin of the Rocks, Madonna, Children and Saint Anne. At the age of 67 this great artist died on 2 May in 1519 B.C.



**Task:** Was Leonardo Da Vinci only an artist? What are some of his other introductions? Explain in six sentences.

## Lesson 4

### Michelangelo (1475-1564)

Michelangelo was born on 6 March in 1475 B.C. in a small town called Castle Caprese, near Florence in Italy. Michelangelo was considered the greatest living artist in his lifetime, and since then he has been held to be one of the greatest artists of all time.

Realizing his interest in art, sculpture, architecture, and humanities, his father admitted him to Domenico Ghirlandaio to take art lessons at the age of 13. Here he took lesson for only 3 years. Before coming to Ghirlandaio he was already

skilful in sculpture carving. Here he took lessons on painting , architecture and sculpture. He could beautifully draw paintings, create sculptures and could produce accurate beauty and glamour to the stone carved statues. He could not lead his life as lavish as Leonardo Da Vinci. By hard work he earned wealth,

education, experience, and fame. He had to pass through many ups and downs in his artist life that caused sorrow till the end. In his later years he was not happy but still he had great trust and confidence in his work. Like Leonardo, he also dissected human bodies to observe the growth of muscles and the diaphragm in the inner part.

Looking at his paintings or sculptures one can easily notice his experience and knowledge about human physiology. Every organ of human being was neatly and clearly exposed in his paintings. Michelangelo liked sculpture work more than painting and he became famous for carving sculptors. Statues were made of metal and stone. *Pieta* sculpture is one of his best and



Michelangelo



La Pietà

extraordinary creations in the world. This statue is the property of Saint Peter's Church in Rome now. The statue 'David' is in the Florence Academy. Bond Slave is in the Louvre Museum. He was not only good at creating sculpture but also good at paintings. People still see wonder in the paintings created by Michelangelo at the ceiling in Sistine Chapel in the Vatican City. In his sculpture he exposed the human physiology beautifully. By his pattern of work he changed all the previous

ideas and theories. His technique of art created a new wonder. He is the first person to create beauty and glamour in his paintings and sculptures of prophet and great men. This type of artistic work had splendor and contains glamour and liveliness. The painting depicting life being given to Adam is drawn at the ceiling of Rome's Sistine Chapel. That shows his creation of wonder with sympathy. The fresco of The Last Judgement on the altar wall of the Sistine Chapel is another wonderful creation.

Michelangelo was a bachelor throughout his life. He used to lead his life like hermits. Though he was having irritating behavior in his later years, people still respected him for his talent.

In the year 1564 B.C. in the month of February, while completing the last phase of work at the feet of the famous Pieta, he fell ill. On 17th he was strongly advised by the doctor to take rest. At that time he thought of writing a will in full consciousness. On that will he wrote, "My soul is for God and my body is for the world". At the age of 89, Michelangelo breathed his last at 5 O'clock.

## Lesson: 5

### Raffaello Sanzio da Urbino (1483-1520)

In 1483 B.C., Raphael was born on a good Friday at 9 p.m. in a mountainous city Urbino. His father Giovanni Sanchez was also a painter and culture cultural person. Raphael first started learning painting from his father. At the age of 10, he was allowed to brush and paint over his father's paintings. His father Giovanni sent him to Perugino, a famous painter of that time at the age of 16.



Raffaello Sanzio



Only within 3 years his name became known in the cultural society because of his eagerness and sincerity about painting. His major discovery was to display the layout of the subject of painting correctly. Only in his painting this type of discipline was seen. In no other painting this could be seen.

Raphael was an extremely handsome person. His behavior was also gentle, polite, decent, and he was helpful to others. Anyone who came in touch with him used to become happy. In his youth he got both fame and wealth. But fame or wealth could not influence his character.

Raphael and Leonardo, both the artists were very curious in nature. One used to do research in discovering the mysteries of the world while Raphael was careful in finding the truth.

At the time of Renaissance Leonardo, Michel Angelo and Raphael, these 3 great artists used to paint by, following the scientific perspective. They brought a new dimension in painting by using the light and shadow. Among his famous paintings the painting tilted Madonna, is a wonderful creation of beauty. There was a good story about Raphael's saintly life. When Raphael was very famous in Rome, his opponents hired a killer to assassinate him and at that time,



The Madonna

keeping the door open he was creating the sculpture of the mother statue. After seeing the painting both killers forgot their mission. According to his usual gentle and polite behavior he tried to explain the painting to them. Influenced by his behavior, the killers admitted their crime and asked for forgiveness, and then left. Only at the age of 37 this great artist who was born on a Good Friday died.

**Task:** Write 10 sentences about Raphael's behavior and nature.

## Sample Questions:

### Multiple choice questions

#### 1. When was Leonardo Da Vinci born?

- a. In 1452
- b. In 1442
- c. In 1550
- d. In 1480

#### 2. Which artist was equally skilled at fine arts and sculpture?

- a. Leonardo Da Vinci
- b. Raphael
- c. Michelangelo
- d. Paul Shezan

#### 3. Who drew the painting `Madonna of the Meadow`?

- a. Gogh
- b. Raphael
- c. Matis
- d. Michelangelo

#### 4. The first picture drawn by primitive people was discovered ---probably

- a. 10 thousand years ago.
- b. 20 thousand years ago.
- C. 30 thousand years ago.
- d. 40 thousand years ago.

#### 5. The cave Al Tamira is-

- a. In France
- b. In Spain
- C. In Germany
- d. In Japan

### Questions for brief answers

1. Give your opinion on why fine arts is called an international language?
2. He is not only a painter but also an inventor of many modern scientific discoveries write whatever you know about the person.
3. He was not only expert in fine arts but also equally expert in sculpture. Write the name of the artist and in brief about his works of art.
4. "The subject of drawing pictures is properly arranged"- which artist made this invaluable invention? What do you know about him?

## Chapter Three

### The Folk Art and Handicrafts of Bangladesh

Our folk art and handicrafts are intensely related to the people of Bangladesh, nature and their living. We learnt about the folk-arts and handicrafts in detail in class six. In this chapter, we will learn about some main folk arts and handicrafts, and we will get an idea about the use of folk arts and handicrafts in different aspects of our ways of living.



The pictures of the Folk Art and handicrafts of Bangladesh

**After the completion of this chapter, we will be able to-**

- describe some major folk arts of Bangladesh.
- describe some major handicrafts of Bangladesh.
- describe the fields of use of folk art and handicrafts.
- describe the role of folk art and handicrafts in our daily life.
- make a poster about folk art and handicrafts.

## Lesson: 1

### Some major folk arts of Bangladesh

The area of the folk arts of Bangladesh is very wide. The multifarious world of the folk arts of Bangladesh is made with alpana, designed cake, designed frame, designed fan, cool mat, embroidered quit, designed shika, folk-painting, toys, dolls, works of Indian cork or sponge wood, fence of bamboo and reed, folk ornaments, folk musical instruments etc.

Various folk paintings are made in various religious rites and celebrations in the rural areas of Bangladesh. Muharram related paintings, pot or earthen ware painting or ghot-painting (ghatachitro), scroll painting (patachitro), pot lid painting, mask painting, pedestal painting etc. are among them. These folk paintings are the part of our folk arts. Let us know about some of the major diverse folk art in brief.

#### Alpana

Alpana, a kind of floor painting is one of the main folk arts of Bangladesh. Alpana is drawn in many celebrations of the Bangali. Now we can see the use of Alpana in the celebration of Bangla New Year, birthday, turmeric smearing event in marriage ceremony and on the premises of Shahid Minar and street on 21st February. Besides, we use Alpana to increase the beauty and pompousness of different ceremonies and celebrations. Drawing Alpana in any auspicious occasion is an integral part of our Bangali culture and ancient customs. It was mainly derived from the belief of religion and magic of the ancient Bengali life. Alpana was being drawn in different

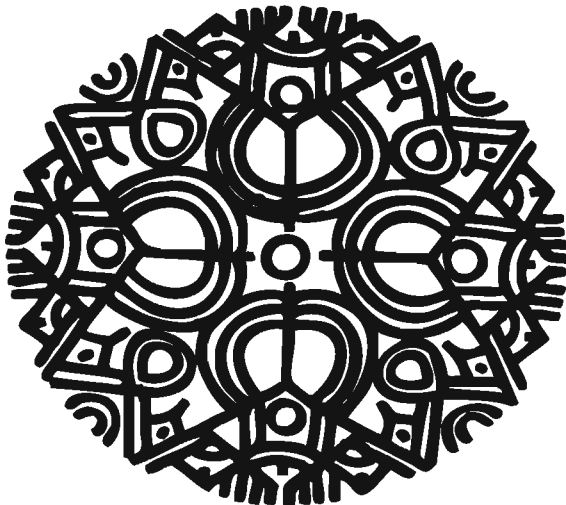

Alpana

kinds of puja and religious functions. For example, circle shaped Alpana is used as the seat or pedestal of goddess at Laxmipuja. One of the frequently used motifs of Alpana is kalki. Kalki is here the symbol of the treasury of Laxmi filled with rice. The family will be enriched if they perform puja of goddess Laxmi by drawing Alpana with this sign or symbol. The granary will be filled with rice. Such Alpana was drawn from this belief.

On the other hand, religious rites



were performed to fulfill the hopes we desire in our family and social life. The different motifs used in the religious Alpana were every single sign of the desire of the mind. Afterwards, Alpana becomes the part of auspicious functions of all sects if Bengali society surpassing the circle of religious celebrations. Now Alpana is drawn using different folk motifs, for example, flower, leaf, fish, bird etc. and various geometric as well as natural shapes. Alpana is drawn in pieces of cloth by dipping pieces of cloth in pulp of rice prepared by grinding it with water and then by using the cloth. There was an ancient

custom of drawing Laxmi Sora Alpana with fingers' spreading powder of rice. Variations of colour were brought with powder of pulse, burnt husk of rice, dust of brick etc. Some traditional and fixed shapes and sizes were considered a special phase of Alpana. This fixed shape and size or design is called motif. But in modern times, changes have been brought in its forms and motifs with the expansion of fields in using Alpana. Diversity has been brought in the use of colour. Now Alpana is drawn with paint-brush mixing aika gum with plastic colour and oxide of different colours.



Laxmi Sora

### Pot lid painting (Sorachitra)

Different types of sketched potlids belong to folk art. The name of the lids or covers of pots is sora in Bangla. Sora is also used in the kitchen. But not painted this way. But this type of pot lid painting is sketched as the component of marriage ceremony of Hindu community. Generally lotus, butterfly and related different paintings are sketched on the lids. But Laxmisora is the most remarkable example of this painting. Laxmisora is the main element of Laxmipuja. It is kept in house for decoration after puja. Different Kinds of Laxmisora are found in different areas of Bangladesh. In Laxmisora the portrait of Laxmi is portrayed with goddess Durga. The portrait of the owl, the carrier of goddess Laxmi is also portrayed. These portraits are drawn with different bright colors in accordance with folk tradition. At present, the sorachitra is not confined to religious

matters only. Now the sora is sketched with various folk matters and designs. These soras are used in decoration of different functions and adornment of houses as well. So, these pot lid paintings are a part of our folk culture.

## Lesson: 2

### Scroll Painting (Potchitra)

Pot as scroll is one of the examples of Bengali folk art. Potachitra as scroll painting is sketched based on different social and religious functions. The word pot has been derived from potto or cloth. Two types of pots were drawn wrapped and square pot. And the artist of this vertically one after another on a pot. These pictures are symbolic to some folk tales or religious tales. Scrolls are drawn on many subjects such as- the life of Buddha, the story of jatok, the love affair of Krisna, Ramayan, Behula, myth of Lakhindar, story of Mahorram, Sonai-Madhob etc. Afterwards, scrolls were drawn on the life story of the folk peer Gazi, Kalu Gazi-Champaboti. These are famous as pot of Gazi.

These scrolls were wrapped fixing with two sticks at two ends. Paintings were drawn on paper fixed on cloths. Besides, paintings were drawn with sticky color on cloths. Some people in the villages narrate the tales of pot in tunes while

roaming with them. From boys to old people including girls listen to the tales of these scroll painting and derive pleasure.

Choukopot as square scroll paintings are drawn on small sized paper. These are usually 1 foot long and 6 to 8 inches wide. Of these, the pot of Kalighat was famous. The variety and standard of art of the pot of Kalighat was outstanding. Lives of good as well as bad sides of the people of different classes and professions of the social customs-good and bad, and different functions were sketched on

them. The Potuas used to sketch a kind of pot named eye donation pot for the dead person in order to get his place in heaven. Eyes were drawn on them in exchange of proper remuneration from relatives after drawing pictures of dead person without eyes so that he can see the path of heaven.



Scroll of Gazi



## Lesson: 3

### Embroidered Quilt

Embroidered quilt is one of the most attractive precedences of Bangladesh. Quilt is sewed with a few pieces of cloth together to put on in winter. Some of the quilts are made with threads of different colors on different designs. Quilt sewed with many designs is called embroidered one. Working day after day during leisure time, the village girls make colorful picture and



Nokshikhata

design appear on quilt by needle and threads. In these pictures, there are many stories or many tales. Village brides makes the stories of sorrow and happiness of their own life appear in the picture with thread and needle. A single quilt sometimes needs one year, even more than two years in some cases. Artistic excellence of some quilt is surprising. The designs on the quilts are flowers, leaves, trees, lotus, moon, stars, birds, fish, different animals, even

houses etc. Again, shapes like line, circle, round shaped house, triangular house are used again and again on quilt. Frequent uses of the same shape or design is called motif. Embroidered quilts are classified into different types according to their uses. For example, *sujonipere*, *lepkantha*, *chador kantha*, *jaynamaj*, *ason kantha*, *palki kantha*, *rumal kantha* etc. There are two main streams or styles of the quilt of Bangladesh. One of them is Jessore style and the other is Rajshahi style. Besides, there two Chittagong, Khulna, Faridpur etc. regions have remarkable styles. The embroidered quilt of Jessore holds the highest position in Bangladesh. The sewing of the quilt of this region is very sophisticated and refined. These quilts are never sold in village fair. These

quilts are made for themselves. But embroidered quilts are made at the order by others in exchange of remuneration. Nowadays, these embroidered quilts are seen to be sold in handicrafts shops in cities. Even, these conventional articles are sold in the international markets.

### **Terracotta**

Terracotta plaques or plates of burnt clay are ancient traditional and very famous folk art of Bangladesh. Terracotta was used in different buildings and architectural structures in the middle age, especially on the wall of temples, mosques etc. The designed plate or terracotta is such a relief work which remains raised on the floor or ground of the plate. First, the plaques are made with mud and then those are burnt. So, they are called plates of burnt soil. The most ancient terracotta plaques were found in archeological diggings in

Mahasthangar that is in ancient Pundra city of Bangladesh. The subject matter of the designed plaques of Mahastangar and Dinajpur is men-women and gods-goddesses. On the other hand, pictures of the then society and nature are found on the plates of Paharpur and Moynamoti of Comilla. The subject matter of Bagha mosque or Adina mosque of Tangail is flower, leaves and geometric design. But at present terracotta



**Terracotta**

is made with different modern subjects

and shapes. Now a lot of terracotta is used in the interior design of offices and houses and also to increase exterior beauties of buildings.



## Lesson: 4

### Some major crafts of Bangladesh

There are many different everyday useable things in Bangladesh among which chopper, axe, spud, sickle, nut crusher, blade of plough, pot, pitcher, earthen cask, many things made of copper, boat, rickshaw, cot, door etc. To add beauty to these objects, craftsmen make scratch marks, engrave on these or even attach leaves, flowers, births or other pictures to these objects. We call these useable materials handicrafts. We use many types of crafts in our country. We will learn here about some remarkable handicrafts among these.

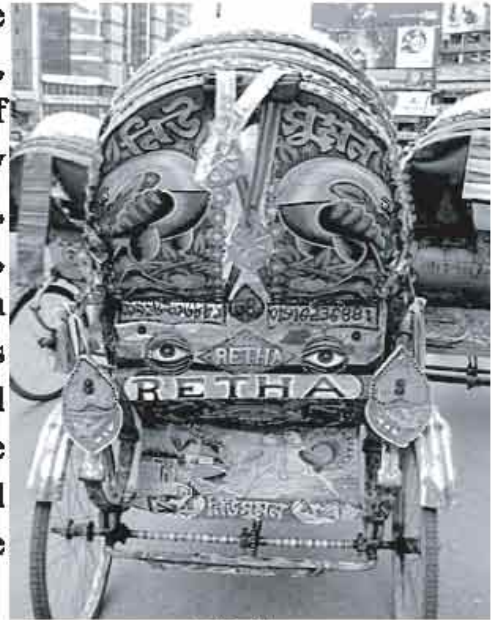

Rickshaw

### Rickshaw

Rickshaw has earned fame at home and abroad as a beautiful craft of Bangladesh. A rickshaw with three wheels is an artwork in its appearance and shape. Nevertheless, rickshaws are decorated beautifully with flowers, leaves or births with made bamboo, plastic and cloth. Sometimes two flower vases are set at two edges of its handles and then flower are hung. Again, colorful rattles are hung around the hood. These create rhythmic sound while a rickshaw plies. Beautiful pictures are set at the back of each rickshaw. With all these, decorations, rickshaw is an attractive craft.

### Boat

The boat is a much known transport in riverine Bangladesh. It is not only a dependable and mostly used water way vehicle but also



Many kinds of boat

a bright example of our handicraft. A boat has artistic excellence in its appearance and shape along with much craft engraved on it. Boats are known in separate names according to their appearance. For example, *goyna*, *pansi*, *bojra*, *kosha*, *sarongo*, *sampan*, *dwip* and fishing boats etc. In the past, there were boats named *Moyurponkhi*, *Tiathoti* etc. The front and the shape of other parts of the boat are designed imitating the peacock, parrot etc. Boats are decorated placing two eyes of brass to the front and sheets of brass and aluminum etc.

## **Lesson: 5**

### **Wooden fence and bedstead (palanka)**

Fence and bedstead (palanka) made of wood are very ancient handicrafts of Bangladesh. Beautiful craft was made on the fence of wood with the face of lion, elephant, and lotus etc. as motif. Fence of wood was once a popular art in the region of Faridpur. There are creepers and herbs at the two sides of the door arch and in between there are two lions. It seems that this custom was derived from the tradition of lion's gate. Like the fence of wood, bedsteads of wood is a traditional handicraft of Bangladesh. Different types of bedsteads adorned with art craft are used in the houses of this country from ancient time. In the past the legs of the bedsteads were given the look of the claws of tigers and lions. Sometimes, they were engraved with picture of the fairy. Two legs of such a bedstead kept at national museum and stands of mosquito nets are held by the fairies. Besides, there are adornment of creepers and herbs. In the villages side the head of the bedsteads is usually adorned with a pair of peacocks.

### **Adorned door made of wood**

Wooden doors with crafts art enriched our handicrafts from ancient time. Doors were adorned engraving the faces of animals like lion, elephant etc. along with the design of flower, creepers herbs. Huge door with crafts of any gorgeous building can easily double the beauty of the building. The Bengalis with delicate taste show their taste by using the door with crafts in their house.

Among innumerable handicrafts of Bangladesh, a few have been discussed above. We can know more about them if we become conscious about the folk art and crafts found around us. Different folk art and crafts have earned fame in different areas of Bangladesh for their artistic quality, skilled work and beauty. When you get any craft at your hand, you should try to know about them with detailed information.

## **Lesson: 6**

### **Fields of use of folk art and crafts in Bangladesh**

The folk art and crafts have noticeable use in different fields in our daily life. These arts are inseparably mixed with our lives for ages. The use of folk art and crafts in different fields has been mentioned below.

#### **Use of folk art in different fields of livings**

Different types of colorful toys made of soil, wood and cloth have possessed noticeable place among the folk arts of Bangladesh. These are very popular as toys for children along with their standard of art. Especially the village children spend their colorful childhood period with these mind blowing toys. Again the reticulated bag, floor mat, table mat etc. made from jute have pragmatic suitability. These are used in every house of villages. Embroidered quilt is the most remarkable and mostly used element of folk arts. This attractive craft is used equally both in towns and villages for its artistic quality and standard. This quilt is used in every home in winter. Even it has popularity and demand outside the country. On the other hand, Laxmisora is the main component of Laxmipuja of the Hindus. Likewise, Alpana, wall paintings etc. have become the part of functions and Bengali celebrations. Alpana and wall paintings are widely used in different functions including Bangla New Year celebration, puja, wedding, birthday, turmeric smearing event in marriages and martyrs, day etc. These make the ceremonies pompous and colorful.

Designed cake is a very popular food in the villages of Bangladesh. Relatives and friends are entertained with these cakes in winter. These designed cakes are beautiful not only to see but also to eat. No function, ceremony and marriage would take place without these cakes. These cakes are a favorite food in marriages and social functions. On the other hand, the use of designed fans during summer is found in towns along with villages. In the Middle Ages terracotta plaques or the designed plates of burnt clay were set in different structures and on the wall of religious organizations to increase the beauty of the buildings. At present, a lot of terracotta is done with modern subjects and nature. The delicate use of this terracotta has been increasing day by day in different organizations and residences. So, we can say that folk art is not simply a medium of art rather it is used in different fields of our daily life. We should be more careful about the expansion of all traditional and glorious folk art. Folk art play an extensive role to make our life beautiful and rich

**Task:** Make 3 lists of handicrafts used as toys, household goods and in the festivals

### Use of handicrafts in different fields of livings

Like folk art, craft is also closely related in different fields of our lives. We know that adornment of different products or things is handicraft. So, it is easily understood that all the handicrafts are used in our practical life. For example, different furniture having art crafts made of bamboo, cane and wood increase the beauty of our houses while they are used in various necessities like for our sleeping, sitting, preserving dress and cloths and keeping food. Different potteries with art crafts made of mud are the main elements of the families of general people. Again, we use various designed utensils made of copper and brass. Beautiful ornaments and saree are everyday used elements of the women of Bangladesh. Designed cot, door, almirah bear the testimony of our delicacy and at the same time, their use is inevitable in our daily life. So, it can be said that these crafts play significant roles in different fields of our life.

**Task:** Write the names of 10 handicrafts used in our everyday life.

### Sample Questions

#### Multiple Choice Questions

**1. What type of major art is Alpana'?**

- |               |                     |
|---------------|---------------------|
| a. Handicraft | b. Cottage industry |
| c. Folk art   | d. Woodcraft        |

**2. Which one is the most famous of the chookopots?**

- |                       |                           |
|-----------------------|---------------------------|
| a. scroll of Gazi     | b. scroll of eye donation |
| c. scroll of Kalighat | d. scroll of Jesus        |

**3. Which part of Bangladesh is in the highest position for embroidered quilt?**

- |             |               |
|-------------|---------------|
| a. Rajshahi | b. Faridpur   |
| c. Jessore  | d. Chittagong |

**4. Where has the example of the oldest terracota of Bangladesh been found ?**

- a. Mahasthangor of Bogra                      b. Moynamoti of Comilla  
c. Kantoji temple ofDinajpur                d. Bagha Mosque ofRajshahi

**5. The fences and cots or bedsteads made of wood is the most ancient form of**

- a. Folk art    b. Handicraft  
c. Cottage industry                              d. Craft

**Questions for brief answers:**

1. What is meant by handicraft?
2. Name five handicrafts which make use of wood.
3. Every day we use various types handicrafts- explain with specific examples.
4. Why the ornament and furniture embellished with crafts work are are preferred by people?
5. Give a short description about embroidered quilt mentioning their different classifications.
6. Write in short about the rickshaw as a popular vehicle and a beautiful piece of handicraft.

**Essay type questions**

1. Our everyday life is tied with Handicrafts- explain it.
2. How will you raise family and social awareness in using folk arts and handicrafts?
3. Mention how the art of painting has contributed in the development of Bangladesh.
4. What is scroll painting (patachitro)? Write what you know about it.

## Chapter Four

### Different media of drawing picture

There are different media of drawing pictures. Picture can be drawn in different media including pencil, ink and pen, water color, oil color, pastel color, acrylic color. In this chapter, we shall learn about- poster color, acrylic color and water color as medium of drawing picture.



**After we have studied this chapter, we will be able to**

- learn about poster colour and its uses.
- describe acrylic colour and its rules of use.
- describe watercolour and its application.

### Lesson: 1 Poster color

To the youngsters poster colour is a favourite color as a medium of drawing pictures. It is mainly water based colour. Picture is to be drawn with this colour after mixing to with water. Poster colour is thick and heavy than watercolor. It maybe called an opaque color. It is because the color is completely covered when one color is pasted on another one. Then the previous colour loses its existence. The poster colour is found in various shades in small bottles of glass. It is preserved in bottles in the form of thick paste. The colour is used on paper after taking it from bottles and mixing it with water. The poster color is generally used to draw picture on paper. The poster color is suitable for use on paper with rough surface. To have the brightness of the picture, it is better to use more than one painting brush and clean water. It is possible to draw any kind of picture with poster color.



Poster Color

**Task:** Draw a rural scene using poster colour.

### Lesson: 2 Acrylic color

Acrylic color is found not only in tubes but also in small and big bottles cans of glass and plastic. It is preserved in thick paste form and pictures can be drawn in it liquid form by mixing with water. Acrylic color can be used to draw pictures on any medium like paper, board or canvas. It is generally an opaque colour. But by mixing to with water, it can be used like watercolor.

Pictures can be drawn quickly because the color dries fast. So, at present acrylic color is very popular among the artists.

All colors can be found in acrylic. The color which is found in the market as plastic color is mainly acrylic. But it is comparatively liquid than acrylic. Plastic colour can be used by mixing it with water.



Acrylic colour

**Task:** Paint a picture using watercolour.



## Lesson: 3 & 4

### Watercolor

The very name of watercolor tells us what it is. The color which is mixed with water to draw pictures is called watercolour. It is transparent. The watercolour is kept in the small boxes in shapes like square tablets. They are also found as separate

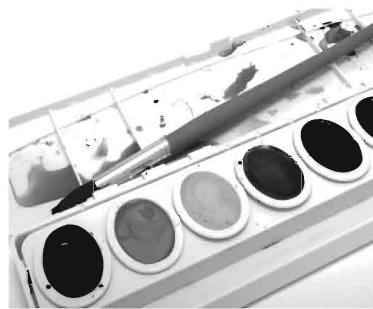

Water Color

tablets. Even watercolor is available in the tube in the form of a paste. Though watercolor and poster color are almost similar, they are much different in quality. Watercolor is transparent and light. One colour cannot be covered with another one. Due to being transparent, the combination of two colours creates one color. The watercolor is generally used on paper. A little thick paper with rough surface is the most suitable medium to draw with watercolor. Watercolor can be used to drawn with thick cartridge paper available in our country. Those who can afford handmade or better types of paper should make use of those types of paper.

**Task:** Draw a picture with watercolor.

### Rules to use water color

Cut a sheet of cartridge paper into halves. You can make it smaller if you like. Remember that the paper should get not shrunk or folded. Ensure that you have cut the paper beautifully. Stick the paper on hardboard so that it remains straight and tight. Place the board in front of you on the ground or lean to against something high. Take clean water in a mug. Keep a few specially made palettes or small plates to draw with watercolour. Keep the color tubes or cans of color close at hand. This is the time to draw a picture now. Think well before starting what you are going to draw. Suppose, you will draw sky covered with black and white clouds. So, start drawing with pencil with strokes. It is good rubbubg again and again. Too much rubbing may damage the smoothness of paper. When color is put, unnecessary lines can be seen on the rubbed places. The pictures may also get destroyed. Before putting color, wet the paper with clean wet cloth or by a wide painting brush. Wait for some time. You will find the water has somehow dried. Now take colour on a small palette. You need to have to have some brown color. Mix the brown and blue color with water and put that lightly on the half-wet paper using a wide painting brush. Remember to start putting



colour from the top of the paper. You will move the painting brush from left to right. The colour will roll down to the bottom like water. You will finish the wash by quickly drawing the rolling color. Thus at the time of putting the blue wash, leave the parts of white cloud according to the drawing. It means you should ensure that the whiteness of the paper is left where needed. Now wait for some time after completing the wash of blue colour. Start the work of black cloud after the colour gets dried. For this, prepare color of your needed amount in two small plates. Then mix blue and black, again black and brown color. Then, according to the drawing, first put some light blue and black colour at the portion of black cloud. Then, to make it darker, put some black and brown mix colour thickly on previous portion. This will create an impression of the darker cloud. Now you will find the type of black cloud wet by rain if you put color this way on wet paper and wet color. Now put the black and brown colour mixing lightly on white cloud where the shed is needed. Your drawing is complete now. Here we have described you a simple process. In this process, a watercolour picture can be drawn within a short time. However, many kinds of colour will be needed according to subject. The colour will vary according to light and shade and you will require more time to finishing. The use of watercolour will have to be learnt by practicing again and again in the class under the supervision of your teacher.

## Sample Questions

### Multiple Choice Questions

#### 1. Which one is watercolor?

- a. Non-transparent color
- b. Heavy color
- c. Transparent color
- d. Oily color

#### 2. Which is mixed to make poster color?

- a. Oil
- b. Turpin
- c. Water
- d. Gum

#### 3. How is acrylic color preserved?

- a. In the form of thick paste
- b. In the form of liquid color.
- c. In the form of color stick.
- d. In the form of cake

#### 4. Why is acrylic color favourite to the artist?

- a. Because the color dries very fast
- b. Because the color is bright
- c. Because the color is not wiped out
- d. Because less color is required

#### 5. What is generally used to draw pictures with watercolor?

- a. Canvas
- b. Paper
- c. Hardboard
- d. Pieces of wood

### Question for brief answers

1. Separate the colors from below which can be used only to draw picture on white paper. Acrylic color, plastic color, watercolor, oxide color, poster color, tie-dye, pastel color, oil color.
2. Write in brief about poster color.
3. Describe the rules of how to use watercolor.
4. 'Acrylic color is now a favorite medium to the artists'- explain.

## Chapter Five

### Various Interesting Practices of Drawing Pictures



After we have studied this chapter we will be able to-

- Draw interesting pictures with numbers.
- Measure the shape and structure of daily useable things.
- Draw designs with the shape of fish and birds.
- Draw different designs on our own imagination.

### Lesson : 1

We shall now learn how to make and draw the interesting pictures which will give us entertainment. In class six, we learnt to draw flowers, leaves, designs in the light of general rules. You will draw the interesting pictures by yourself at your sweet will. We have been using the numbers 1 to 9 to solve mathematics since our childhood. We are still using them and have to use these numbers for our necessity throughout our life. The interesting fact is you may not thought that interesting pictures can also be drawn using these digits . Now we will get entertainment by making interesting pictures with these digits and at the same time we will surprise our father, mother, relatives and friends by drawing pictures with three numbers.

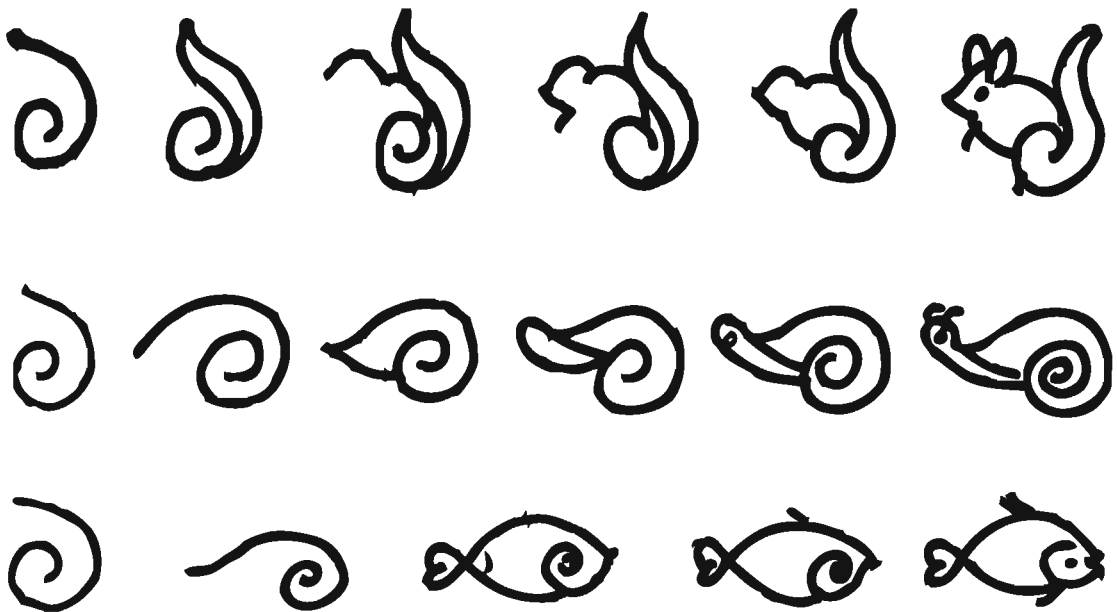

Interesting drawing practices with numbers

**Task :** Everybody display your own interesting drawing exercises using the Bangla numeral 1.

**Lesson : 2**

Interesting drawing practices with digits

**Task :** Everybody display your own interesting practices as your wish with the Bangla numbers 2 and 3.

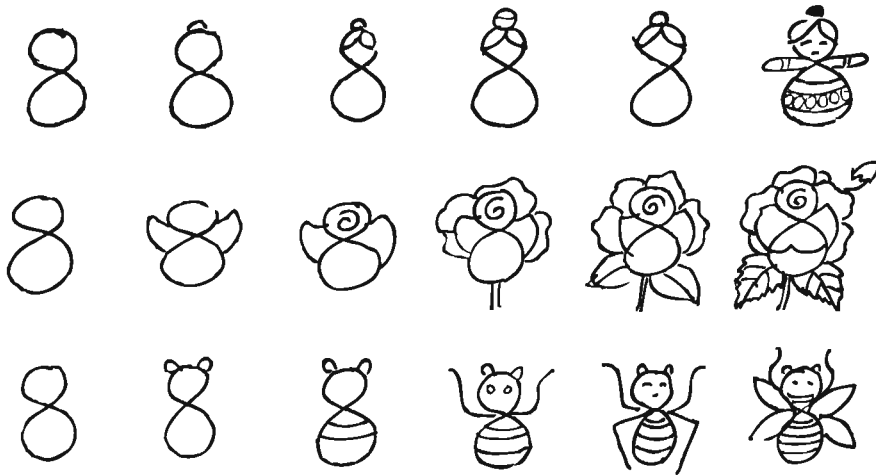
**Lesson :3**

Interesting drawing practices with number

**Task :** Everybody display your own interesting drawing practices as your wish with the number 4 in Bangla



### Lesson : 4

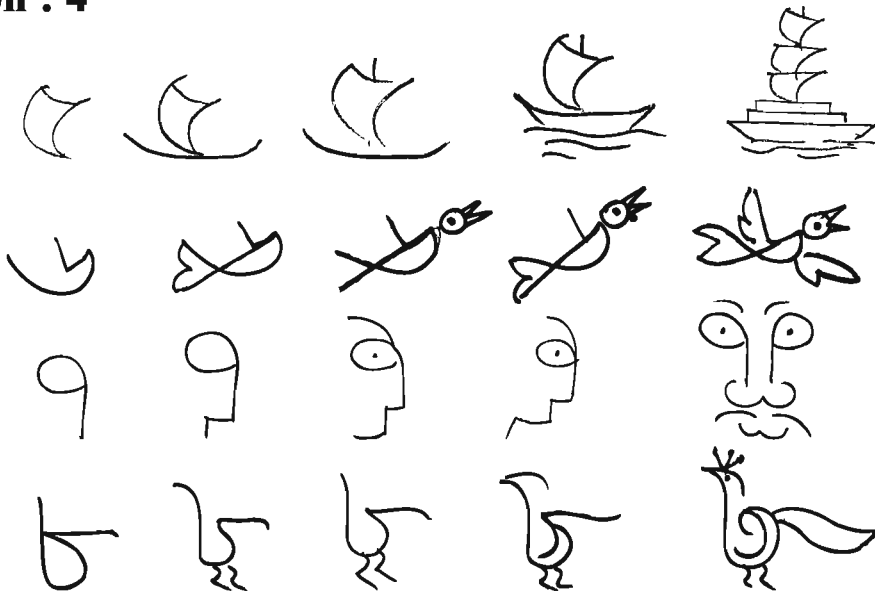

Interesting drawing practices with numbers

**Task :** Everybody display your own interesting drawing practices as your wish with the Bangla numbers

### Lesson : 5

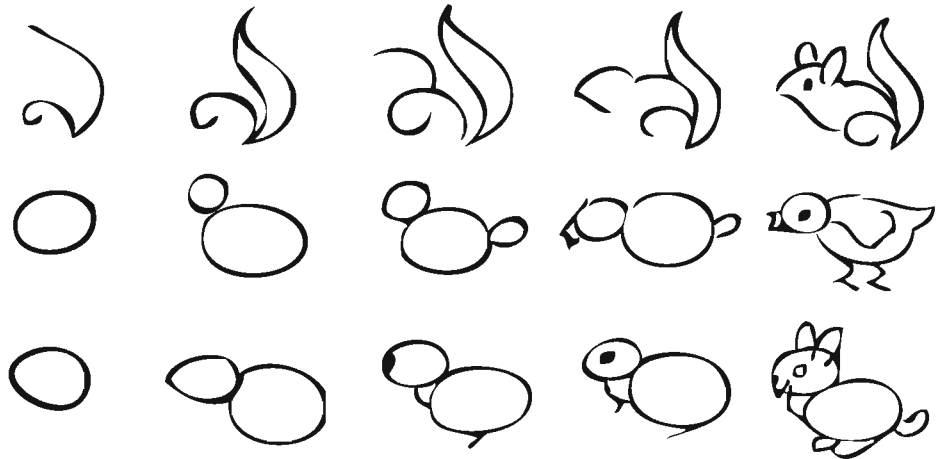

Interesting drawing practices with numbers

**Task :** Everybody display your own interesting drawing practices as your wish with the number 4 in Bangla numerals 9 and 10

## Some initial talk about drawing pictures

We have to be very conscious of the shape and size of the objects while drawing pictures that we see around us to draw them realistically. This is really very important. We have got a conception about shape and size in the previous lesson. Most of the things in the world are circular, rectangular or triangular. Specially all the dots among circle or rectangle can be shaped initially. An interesting fact in realistic drawing is whether the size is big or small, the shape is fixed.

For example,

Same shape same size



Same size different shapes



Same shape different sizes

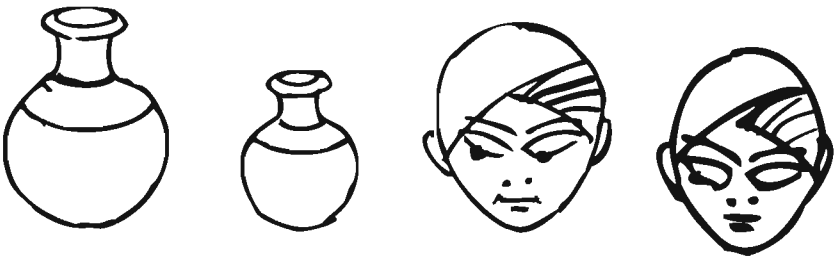

Different sizes different shapes



We said it before that drawing any picture means a collection of lines that can be either straight, curved, circular or any other type. So, each line carries same importance in case of drawing.

Some exercises are shown with the combinations of different lines-



Exercises in combination of lines

The things we have to remember while drawing any picture are subject-matter or length, breadth, height, its proportion to see the balance and to pay attention to its proper structure etc. Any object or matter whatever we draw conforming these concepts, it will present beauty.

## Exercises from nature



All that we see around us is nature. This nature has colourful appearance. It changes its appearance from sunrise to sunset. The appearance of nature in the soft light of morning changes by the sharp light by noon. Again the appearance at sunset is of different feelings and all these take place in the change of light and shade. Again, it changes differently in the diversification of seasons. The nature is adorned with different appearances in paragon beauty during Summer, Rainy season, Autumn, Late Autumn, Winter and Spring. We all love to see natural scenery such as different scenes of rural Bangladesh, fields wide up to the horizon, the far off sunrise or sunset or the extra ordinary beauty of riverine Bangladesh. Sometimes, neat and clean roads of cities, blue sky, urban civilization - all these also touch our mind. You have to observe the facts deeply before you draw these scenes. Imagine, you have gone somewhere to travel. You can see are fields after fields, small cottages at far away place even at a more distance a few boats with sail in the river, a few birds flying in the sky, and some palm trees in the front. Keeping the picture in your mind, when you will sit to draw at your home, you will draw with the fantasy of your mind following the general rules that you knew beforehand. When you follow the general rules such as keeping to size,

shape, proportion of distance, light and shade etc and use your imagination, the picture will be more lively to you. So, the more you increase your power of observation before drawing anything, the more lively will be the picture.

Practice drawing different objects from nature conforming to all these rules under the supervision of the teacher.

## Design

### Design with the geometric and natural shapes

We knew about the techniques of drawing designs with various shapes like triangle, square, circle etc. in class six. We also practiced of drawing designs with flower, creepers and herbs. Now we will draw many beautiful designs by drawing the shapes of bird, fish etc. Before drawing any design, we will separate the designs by their size and shape and then we will put them in a particular dimension to make a beautiful design.

Design can be for the need of different activities. For example, design is needed to employ artistic appearance to the border of saree, neck design of kameez or punjabi, table cloths or cushion, vase, designed pot or many other things.

**Task :** draw a design according to your wish with the measurement of 6" × 6" inches using the shape of fish and bird.

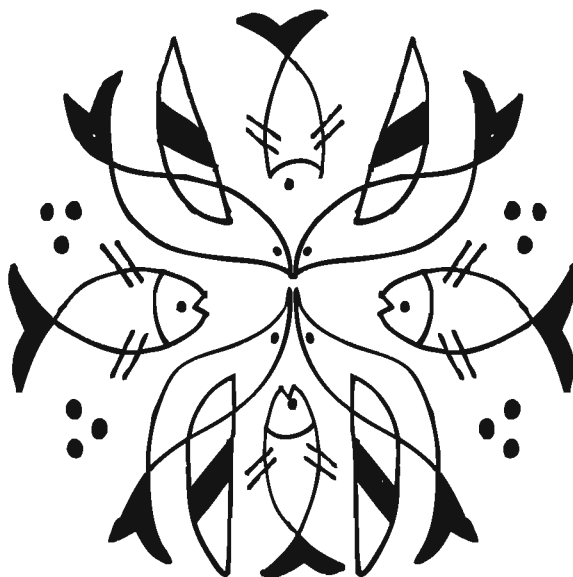

Design with the shape of fish and bird

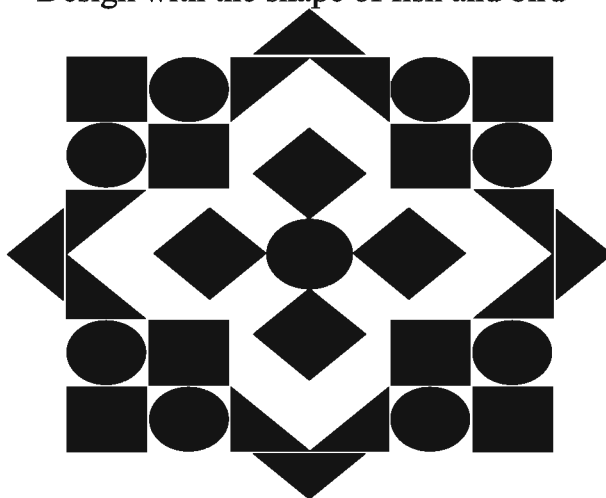

Design with of geometric shape



## Sample questions

### Practical

1. Make an interesting exercise with a number of your choice.
2. Draw any three objects showing their different sizes and shapes.
3. Draw a picture of one of your favourite seasons in poster color or watercolor.
4. Make a pencil sketch of your choice using 2b and 4b pencils.
5. Draw a design with the measurement of 6" X 8" using the shape of fish and birds.
6. Draw a design using geometrical shapes (circle, triangle, rectangle) with a measurement of 5" X 5".
7. Draw a circle of 3" in diameter using any natural shape.
8. Draw a design by using letters.

## Chapter Six

### Different Types of Crafts



**After we have studied this chapter, we will be able to**

- make different types of fancy toys with cotton.
- make cushions of different colors.
- make gates or banners with cotton for different programs.

#### **Needlecraft**

- make stitches in fabric with needle and thread.
- make different stitches and make different designs after learning their names.
- make different types of toys by using fabric and cotton.

#### **Art works with waste materials.**

- make different things with waste materials.
- decorate our houses with those things.
- express the artistic qualities of rejected materials.
- make designs by using the pieces of potatoes and ladies' fingers.

## Lesson: 1

### Crafts made of cotton and fabric

Let us make a picture of a beautiful duck with cotton. Besides this, we will make pictures of flower vase, bird, cat and other things with flowers and leaves of different colors. Let us make a cushion with a cover.

#### Materials

Cotton is the main material to make any crafts with cotton and we can easily understand. We also need- cotton used for bandage, simple cotton wool, different colors, fabrics of different colors, pitch board, hardboard, white paper, carbon paper, glue made from flour, aika glue, scissors, needle, thread etc. However, there are two types of cottons. For writing and cushion making and for making quilts, we use simple cotton wool and for pictures we use bandage cotton piled up level by level. Besides, we need fabrics of different colors, white paper, color paper, chalk, thick white paper or brown paper etc.

## Lesson: 2

### Writing with cotton

Now we can start writing with cotton. We need certain length of color fabric. We can take red, blue, green or violet whatever color we like. Colors should be dark because light color will not look good. Let us spread the piece of cloth on clean floor or a table, and then we write the target writing in big letters with a chalk. Let us make little balls with simple cotton wool. The way we make the ball of flour to make bread by putting clod of flour on our palm rolling with another palm, in the same way we will make the ball of cotton. Now on the cloth where letters are written with chalk, we need to put the thick glue of flour over those letters and fix the cotton balls by pressing one by one. It is needed to fix the cotton balls very closely, one beside another. We will fix the glue in the size of a fifty paise coin on the cloth just under the cotton ball. We will make same size cotton balls. Use of small and big cotton balls will not look good in the same writing. Width of a cotton ball could be 2 or 3 cm. For thick font we need big balls and for thin font we need small balls. By seeing the picture we can write any writings using cotton balls.



Writing with cotton

### Lesson: 3

#### Picture with cotton

The picture we are going to make will have different colors of flowers like white, red, yellow, orange, violet etc. and green leaf and stalk also. There will be flower vase also; so we need cotton of different colors. We could find water soluble powder colors in the market. If we do not get necessary colors in the market, we will make our desired colors by mixing one color with another. If we mix red and yellow, we will get orange color and if we mix red and blue, we will get violet color. The green color we get in the market is not green leaf color. If we mix a little red color with the green colour, we will get green leaf color. The color cottons we will use in the painting must dry up before using them in the drawing.

The picture we will make with cotton has to be drawn with a pencil on a piece of paper. We will draw the picture on the paper as big as the cotton picture. There will be different colors of flowers in the picture. So the flowers will be of different kinds in big and small sizes. Different flowers' leaves will be of different sizes and shapes. We draw this picture keeping these things in mind. Now, we will keep the picture sketched with pencil on a carbon paper. We will use clips or pins to fix the paper so that it does not get displaced due to movement. Now we can draw the picture with a pencil on the paper by following the sketch. We will get a reverse picture on the back side of that paper fixed on the carbon paper. We will make two or three more reverse mark of the sketch. We will color the picture drawn by pencil first so that we

can decide which flower will get which color while making the picture with cotton. What will be the color of flower vase? What will be the colour of leaf?

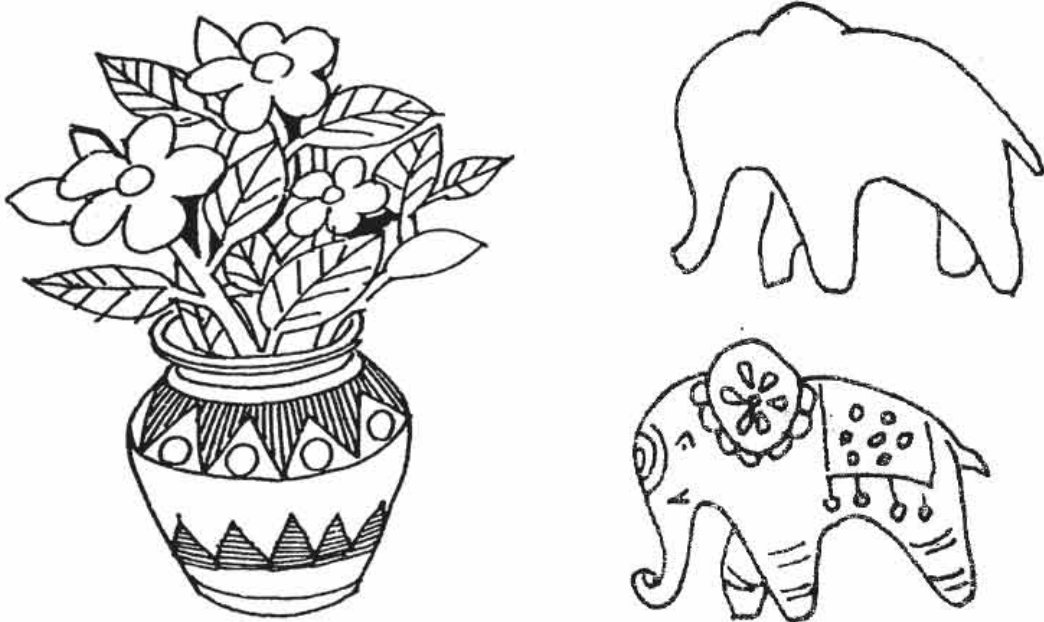

Picture with cotton

Now let us take different pieces of paper which we have cut separately. We will put flour glue at the back of picture marked paper where we will try to press cotton of certain colors about 1 cm. thick so that they get pasted properly.

This way we will fix cotton on every piece of paper and leave them to dry up. We will have enough space around the picture. We will take a strong board of same size and a piece of black cloth 5 about cm. bigger than the pitch board in both length and breadth. The cloth should be ironed properly so that there is not any fold on it. Putting the pitch board on the cloth, we need to paste the glue in every corner and fix the extra paper by folding it with the board properly. We should be careful that the cloth should not be fixed loosely; rather it should be fixed perfectly without any fold. Now we will cut the cotton pressed paper with sharp scissors by seeing the carbon paper's mark to make cotton flower, leaf, stalk, flower vase, etc.

We will fix the cotton flower vase, flower, leaf, etc. on the pitch board attached black cloth exactly by seeing the colorful drawing on paper. After arranging the picture properly, we will take part by part in hand to put glue at the back side and paste them back in the place on the cloth. We should be careful that all sides of the parts of the picture are fixed properly, and no side is left loose. Now we will see the picture made of different colorful cotton looking very beautiful. Flowers



made of different colorful cotton looking very beautiful. Flowers and leaves seemed to be soft like the real ones. If we try, we can make beautiful pictures like this one after our wish. To set stamens inside the flower, we need to cut the petals separately and set the cotton of another color as stamen, then fix the petals around them. Not only the picture of flowers with leaves but also human illustration with different colors of dresses, animals, birds, trees etc. could be made by this way. Cotton made illustration usually look very attractive if we could frame it with glass and hang it on the wall.

## **Lesson: 4**

### **Needlecraft**

We see mother sews at home. They do a lot of needlecraft. For example, they make dresses for us or beautiful design on dresses etc. We also do many things with needle and thread. For example, we fix buttons, fix torn cloth, small handkerchief, table cloth etc. We use quilts at many of our homes both in the villages and towns. Some are normal quilt while some are embroidered. Different colors of thread and designs are found in quilt. It looks fantastic. Birds, fish, flowers, creepers and herbs, elephants, horses, human figures etc. are usually presented in a quilt through illustrations and designs by sewing it with color thread. There are some people who frame the small size embroidered quilt to decorate houses. We call this craft as needlecraft. This craft is one of the important subjects of fine arts. For years, our grandmothers used to sew handmade fans, towels, prayer mats, quilts etc. with different designs. They used their leisure time in sewing a quilt and it took many days to complete one. They presented their stories of joys and sorrows through different designs by using Different types of Different types of needle and thread. In the villages of Bangladesh general women are still making this kind of embroidered quilt. This embroidered quilt is well known and famous to people all over the world as folk art. There are a number of collections of these Bangladeshi folk arts in different museums of Bangladesh and abroad. At present this craft has a great usage in Bangladesh.

Mitigating the personal need, it is also sold in the market. Its demand has increased commercially. By exporting this folk art, we are earning a lot of foreign currency. Needlecrafts are usually done by the village women. This craft not only enriches our thoughts of beauty but also mitigates our needs. Embroidered handkerchief, table cloth, saree, kamiz, scarf, pants, frock for children, curtain etc look very nice. We ourselves are interested in wearing this kind of dresses. So, by learning this craft we could be self dependent commercially after mitigating our personal needs. The main subject of needlecraft is the proper use of different stitches and different colors of thread.

## Materials

Different types of thin and thick needles. White or color thread or wool. Pencil to mark the cloth. As much cloth or jute sack cloth as needed. A pair of small scissors. A frame (which is used to sew using needle and thread). A box to keep the materials. A scale or a measuring tape to measure the cloth. Are all the materials ready?

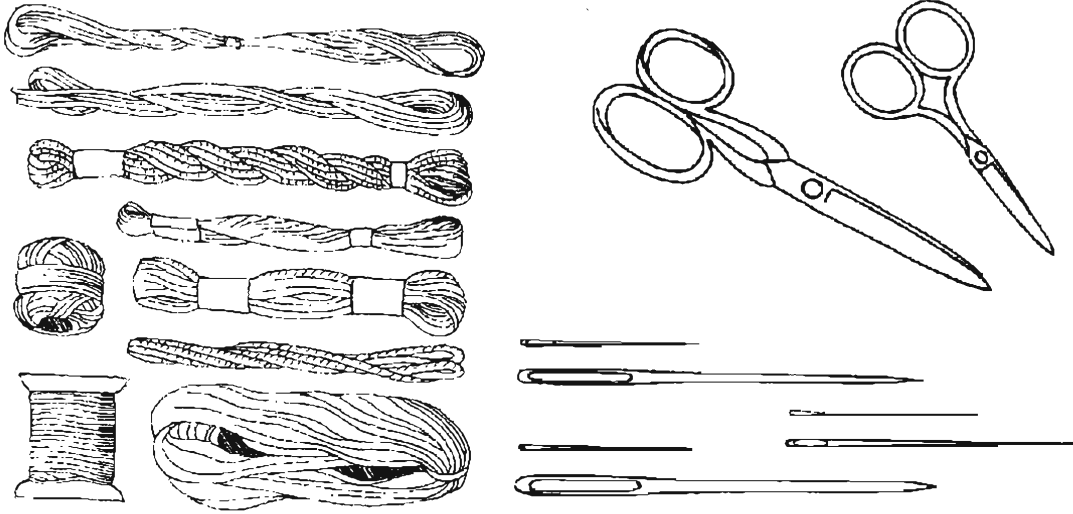

## Materials

Now we need to know different sorts of stitches if we want to make designs with needle and thread on cloths or jute sack cloth. Many types of stitches are used in needlework or embroidery. Here we will know about some stitches and how they are to be done, how they look like and then we will be able to make the stitches.

## The name of the stitches

1. Running or straight stitches or run sewing
2. Hem stitches or side sewing
3. Bokheya stitch
4. Stem stitch
5. Chain stitch
6. Lazy daisy stitch
7. Cross stitch

8. Star stitch
9. Button box stitch
10. Blanket stitches
11. Satin stitch
12. Herringbone stitch

### **Running or streight stitches or run sewing**

Of the different stitches, run sewing is the easiest. The cloth which will be stitched will have to be held high with left hand and will be sewed with the needle in the right hand. Keeping the cloth in left hand, hold the cloth keeping on the remaining four fingers and pressing by the thumb. Holding the needle in right hand, 3 to 4 stitches can be made together at go. But every time after 3-4 stitches, the sewing should be made tight by drawing the thread. To learn running stitch, use colorful thread in case of white cloth and white thread in case of colorful cloth. This is because we will easily understand whether the sewing is going straight or equal. Besides doing line sewing, filled sewing can also be done with this stitch. Running stitch is abundantly used on embroidered quilt.

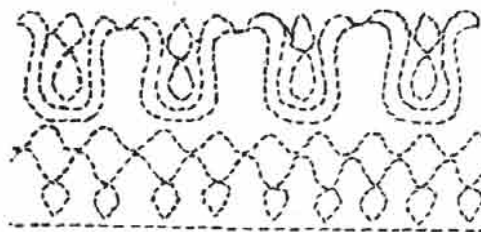
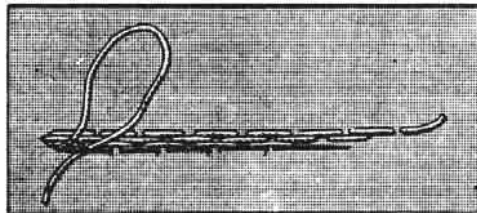

**Runing stitch and design**

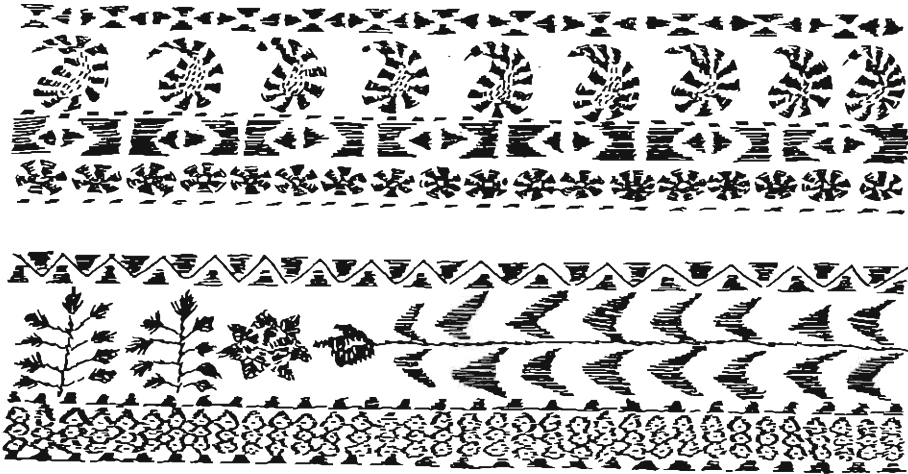

Running stitch, filled sewing and design

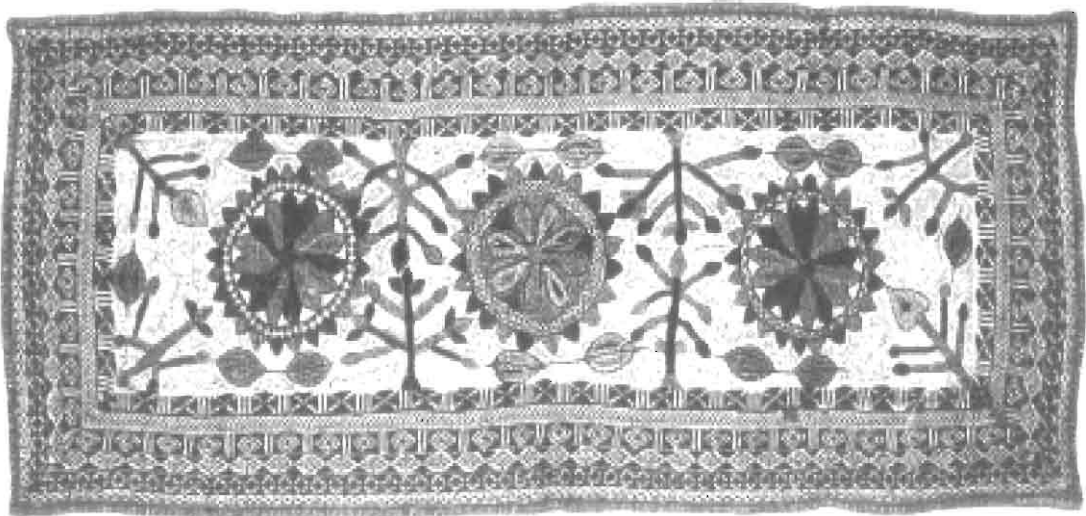

Running stitch in embroidered prayer mat

### **Hem stitch or gutter sewing**

This stitch is used to sew the gutter of any clothing item like table cloth, handkerchief and frock etc. The stitch used for sewing the gutter of table cloth, handkerchief, frock etc is called hem stitch or gutter stitch. The side of the cloth should be folded in a way during this sewing so that the threads do not come out. By this stitch, design can be made in applique on cushion, frock, saree, table cloth etc. Applique is to make designs by setting color cloth on another cloth. By learning hem stitch or gutter sewing, we will be able to do different works in applique method.

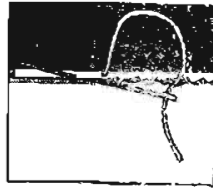
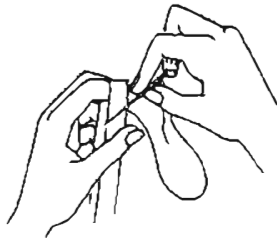

Hem stitch or gutter sewing



Applique work with hem stitch

### Back Stitch (Bokheya stitch)

Back stitch looks like sewing of a machine in the straight line. To make this stitch, needle is to be run from underneath to above like running stitch. Again, stitch is to be made with needle at a bit ahead and above. Take back the tip of the needle to the previous stitch. Again, make a stitch from below to above. Thus advance to the front with stitches. We will see the stitches start to look like the sewing of a machine. This stitch is generally needed to join parts of shirts or other cloth items. The joint of back stitch is very strong. Besides this, different types of designs can be made with this stitch. For example, we can reflect the picture of a fish following the lines of a sketch of a fish made with pencil on a 25 cm wide and 25 cm long cloth by using stitch. We can do many more designs with back stitch.

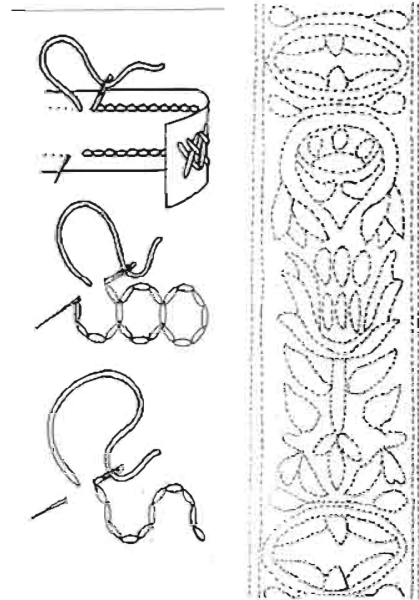

Back stitch & design of Back stitch

### Lesson: 6

#### Stem stitch or branch stitch

Branch stitch is generally used to design branches of tree, flowers and branches of leaves, creepers etc. The line becomes twisted like rope if the sewing is done on the line with this stitch.

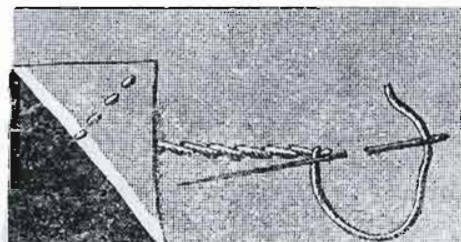
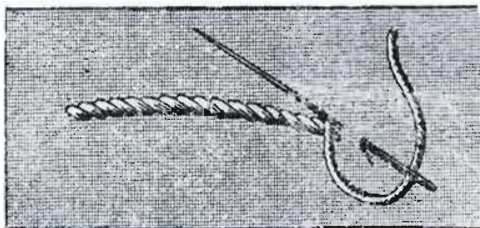

Stem stitch or branch stitch



while sewing with branch stitch, the stitches will come from front to back step by step. Put a knot at the end of the thread after fixing the thread in the eye of the needle. Take the front of the needle from the back of the cloth to the front. Get the tip of the needle to the right between the stitches back aside where the tip of the needle got. Again, insert the tip of the needle putting aside at left where the tip is and take the tip of the needle at right between the stitches. Thus come from front to back stitching one after another. Let us see how beautiful the sewing looks. The design is knitted with a stitch.



The design is made with branch stitch

## Lesson: 7

### Chain stitch

This stitch mostly looks like a chain. Take comparatively coarse thread for chain stitch. Tie a strong knot at the end of the thread. Or knit a strong stitch. Get needle and thread above. Now, knit a stitch sending the thread to the left with right hand at the point of the needle. We will see that the stitch looks like a chain (leave the thread loose while rounding hand). Take the needle from below to upward inserting it by the side of the previous stitch. Put the needle always on the thread while stitching. Knit stitch again rounding the thread from right to left. Thus, knit the thread from below to up by inserting the needle beside the stitch.

Any dress can be designed with chain stitch. Designs of flowers or creepers and herbs can be made specially on frock, saree, handkerchief, table cloth etc. with chain stitch. We can use this stitch in filled sensing work too. We can use this stitch to bring diversity in fine arts.

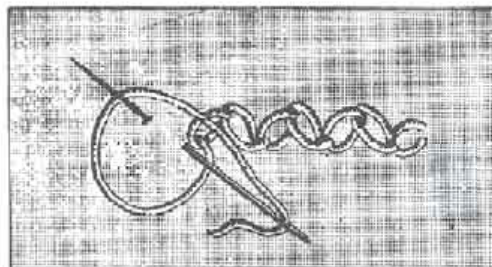
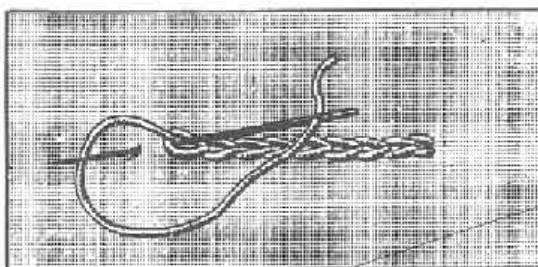

Chain stitch



## Lazy daisy stitch

Lazy daisy stitch can be done like chain stitch. But the stitches of chain stitch advances following a line and this stitch has separate chain stitch. Handkerchief, dresses of children or any cloths look beautiful if bunches of flower, design, creepers, leaves etc. are made on them with this stitch.

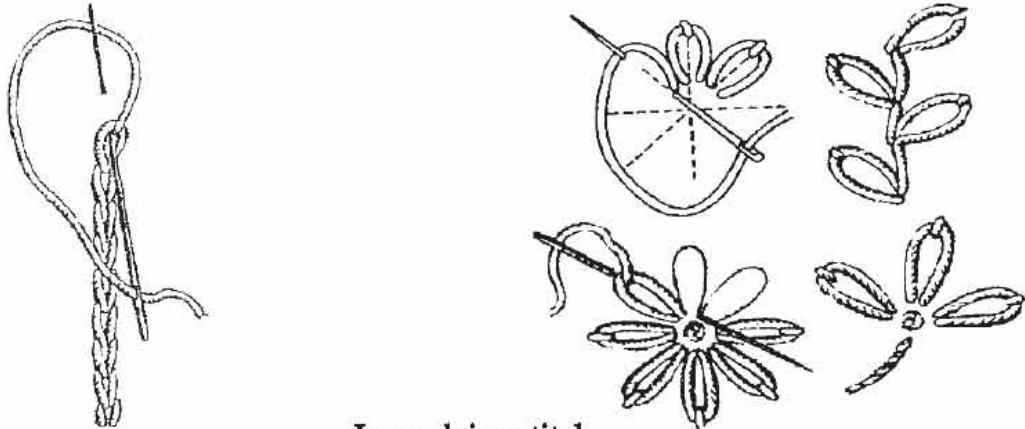

Lazy-daisy stitch

Now let us make the design appear on a handkerchief drawing flower, creepers and herbs with lazy daisy stitch. We have learnt many types of stitches. Now, let us make a handkerchief and a table cloth. We all need a handkerchief. We keep a handkerchief with us when we start for school or anywhere. Then, let us learn to make a handkerchief first. We can use the handkerchief ourselves learning the sewing of it. We can also gift them to others.

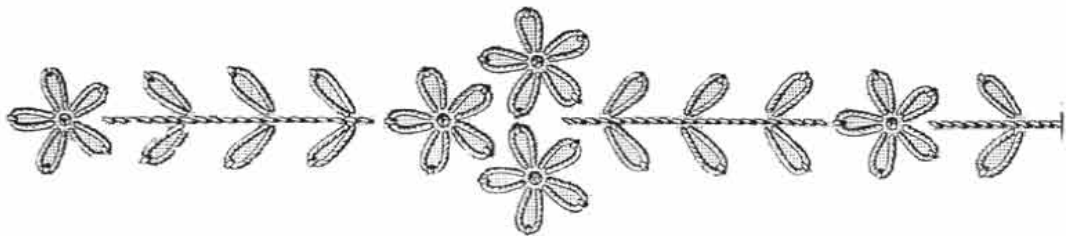

Design by lazy daisy stitch

## Lesson: 8

### Cross stitch

This stitch is much like a cross or 'multiplication' sign. Usually net or cellulose cloth is used for cross stitch. The ground of cellulose cloth is like table like boxes. This stitch is beautifully knitted on sack cloth as well.



The design of a jacket with cross stitch

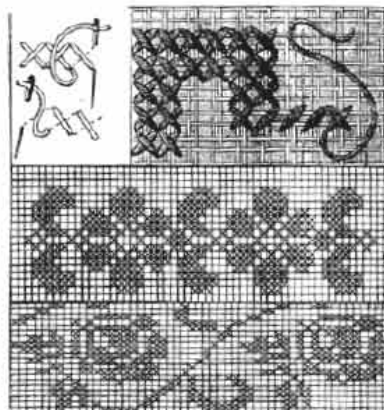

Let us do the design counting the boxes on graph paper

## Star stitch

Star stitch is more like a cross stitch. We can easily knit this stitch seeing the picture. This stitch is easy to knit on checkered cloth or sack cloth.

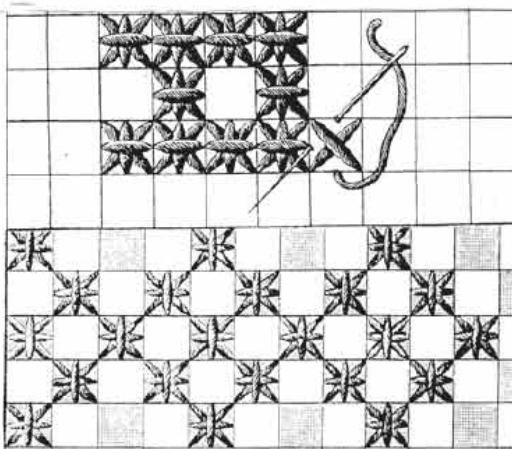

Star stitch

## Lesson: 9

### Button box stitch

After cutting button box in any dress, the face of button box is tied by sewing so that the thread cannot come out. The special stitch by which this sewing is done is called button stitch. (Let us do it by seeing the picture)

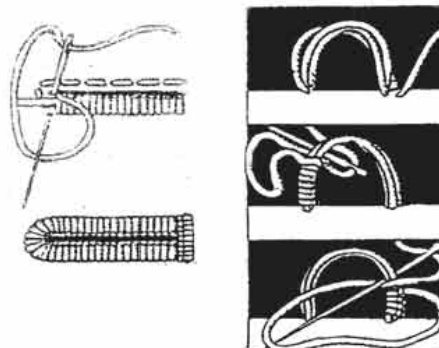

Button box stitch

### Lesson: 10 Blanket stitch

This stitch is used to sew the border of shawl, blanket etc. Blanket stitch is very easy. It is much like a button box stitch.

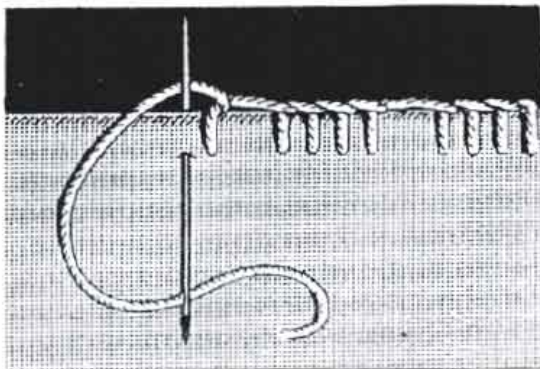

Blanket stitch

### Satin stitch

Satin stitch is also very easy. We hope you will be able to do it by seeing the pictures. This stitch is generally knitted side by side.

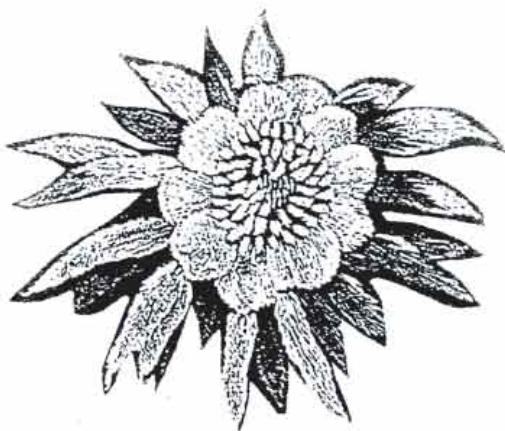

Flower and leaves with satin stitch

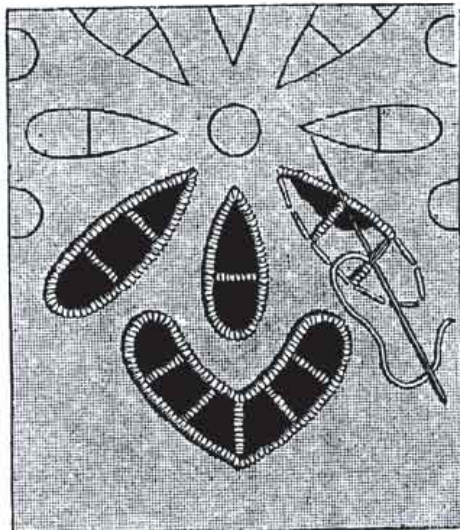

Cut work with button box



Design made with satin stitch

## Herringbone stitch

This stitch is much like cross stitch. This stitch is knitted as cross stitches are. We hope you will understand this stitch by seeing the picture here.

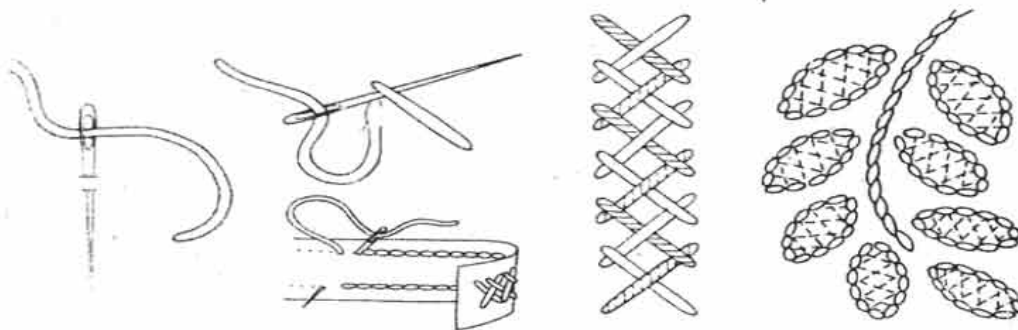

Herringbone stitch and design

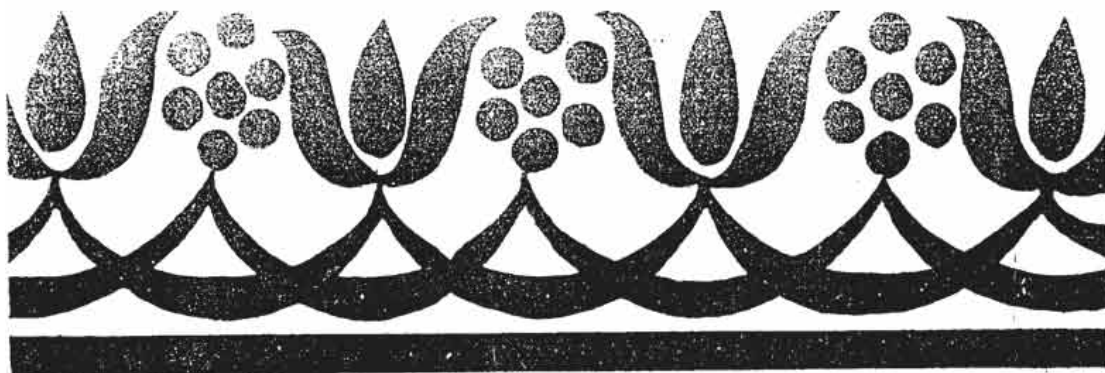

Let us practice this design with herringbone stitch

## Art work with waste materials

We throw away many things considering they are of no use. We call them rejected things. We can make many beautiful artworks with these rejected things using our imagination. There are many things lying around us which are found naturally. They are rejected things in our eyes. Beautiful things can be made with such things that we do not notice or do not come to our notice. We can make rejected things like dried branches of trees, jute-stalk, pieces of wood etc. into lively and attractive artworks with beauty using our strong will and imagination.



Let us know about some artwork like these.

### Flowers of paper on dried branches

Take a small branch of plum tree with thorns. Branch of any other tree will also be useable, but that must be thorny. Make 2.50 cm wide long pieces of white or yellow paper of kites. Make a piece of paper 2.54 cm wide and 15 cm long by folding it three or four times. Now cut one side of the piece of paper with scissors in thin parts. You should leave about 6 cm wide part on the other side which has to be left not cut. Thus the slice of cut paper will somewhat look like a comb. Unfold the paper after it is cut.

Let us take a few pieces of jute-stalk selecting the narrowness at the top, and then cut the upper end of the groped of jute-stalks equally with a sharp knife or blade. Now attach the glue of flour at the side of uncut part of the comb-like paper and round the paper from one end with joint to the top of the jute-stalk taking 635 cm space which was levelly cut. One fold will be put on another. Thus separate the slice of paper after five to six fold. Now, cut the top of the jute-stalk with paper from the fold with sharp knife or blade. Now, spread the narrow heads of the paper folded with pieces of jute-stalk. How beautiful flowers they have become,

Thus we can make flower one after another by cutting folded paper with comb look at the top of jute-stalk. Take another piece of jute-stalk after finishing the other. After we have made required number of flowers, fix a flower with each thorn of the branch. The bottom of the jute-stalk is softer than the thorn of the branch, so it will not be difficult to fix. Fill the whole branch with flowers. How beautiful they look! Fix the branch of the flower in the soil of a small vase and place it in a suitable location. How our pleasure will be when everybody will take them as real flower from far.

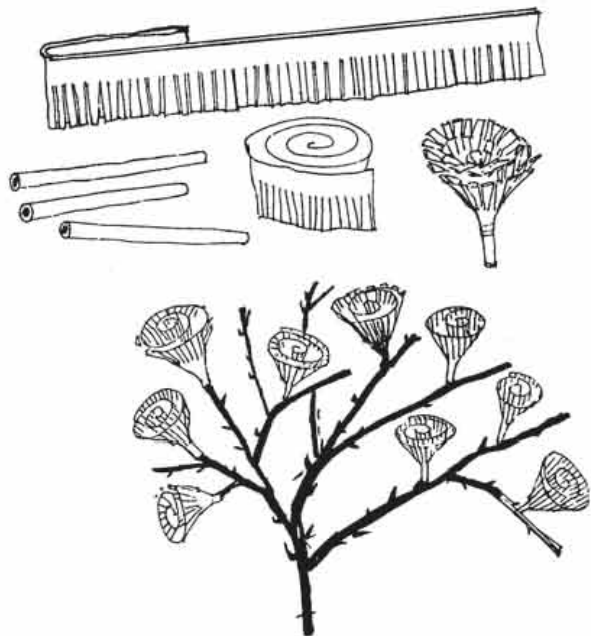

## Mosaic picture

Let us take 8-11 inches cloth and some glue. Sketch a bird on the cloth. Now fix the pieces of paper of different colors carefully on the pattern of the cloth. Pieces of separate colour paper should be fixed around the bird. Keep it in this position for two days. Next, we can display it at home with a frame. We will get much pleasure in doing it. Thus we can make any flower, elephant or any mosaic picture with color paper if we wish.



Mosaic picture

## Print with cutting potato and ladies finger dipped into colour

Print can be taken after cutting potato, ladies finger or bitter gourd with any color (according to circle). Beautiful designs can be made on paper by using blocks of any type of vegetables like potato, ladies finger or bitter gourd. Besides, this printing with new things, beautiful patterns can be made.

### Necessary information

Any colour mixed with water can be used in this context. Here it is shown how printable blocks can be made with soft things like potato curving. If print is taken on particular paper or cloth putting colour on this curved portion, we get beautiful designs.

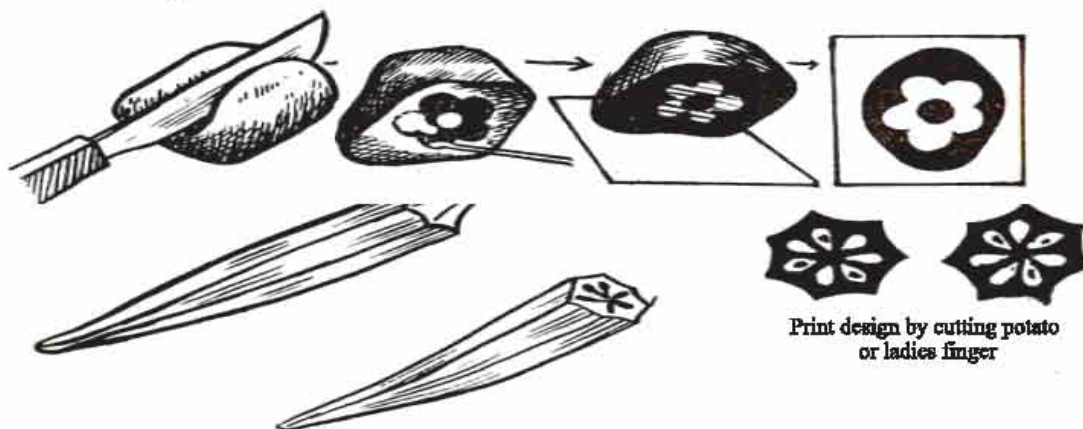

Print design by cutting potato or ladies finger



## Making mask with waste paper

Let us collect enough waste paper. Get the paper wet in water for a day. Make glue with wheat (by cooking). Now, take the paper out from water. Mix the wet pieces of paper with glue of wheat.

This will create pulp ( mondo). Mix some copper sulphate with the pulp. Otherwise, worm will eat into them.

Make middle size ball with enough dry paper, rope or string. Now make the shape of the face of the cat or humans on the surface of the ball with soil like pulp of paper. Dry them for two or three days. Bring out the ball of paper from below after it is dried. Now we have made the mask of a cat or a man. Now, paint them. (We can do this by seeing the picture)

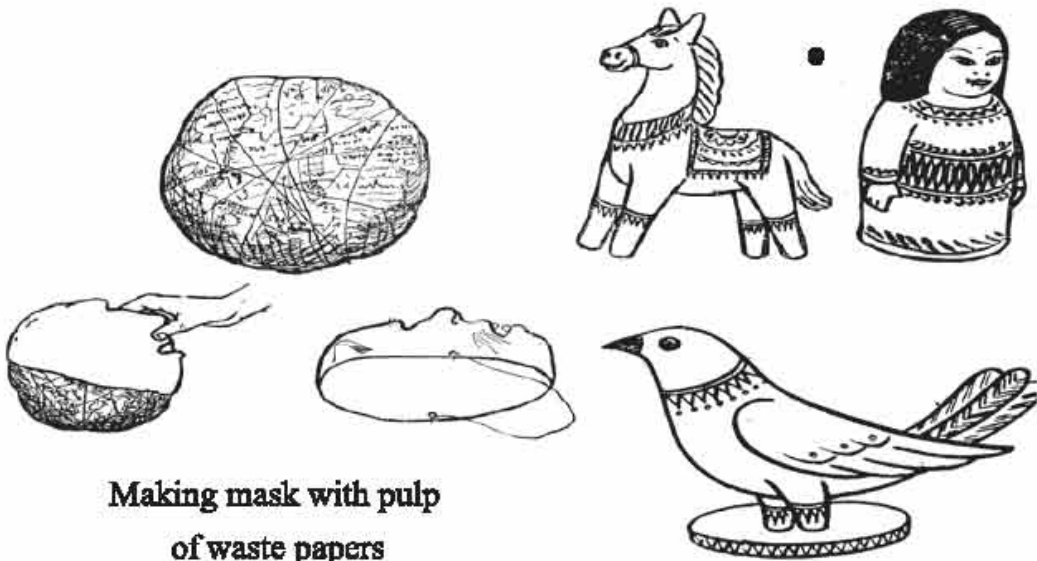

Making mask with pulp  
of waste papers

Toys or dolls can be made  
with pulp as with soil

## Sample questions

### 1. What does needlecraft mean?

- a. Dresses
- b. A design or artwork using needles and thread
- c. Paintings
- d. A kind of handicraft

### 2. What can be done by chain stitch?

- a. Line sewing
- b. Line and filled work
- c. Only thick line sewing
- d. Gutter sewing

### 3. In which case button box stitch is used?

- a) Only in button box sewing
- b. For stitching button box or flowers etc.
- c) Only in stitching creepers
- d. Box or other flowers

### 4. To make picture with cotton, at first you need to-

- a) Draw picture with cotton
- b. Cut out cotton and place the pieces on picture
- c) Draw a picture on cotton and then cut it out
- d. Draw a picture on paper beforehand.

### 5. Which cotton is suitable for drawing picture?

- a General cotton us
- b. Silk cotton (shimul)
- c. Cotton used for bandage
- d. Carpasa or levant cotton

### 6. What will you do if you want to a make color picture using cotton?

- a. Paint is applied after making the picture
- b. It is to be cut into pieces and then dip them each into paint.
- c. Cotton is to be painted and dried beforehand
- d. Cotton is to be colored after making the picture

### Questions for brief answers

1. What is needlecraft? Write the names of five materials of needlework
2. Write the names of five stitches and their areas of usage.
3. Why are you interested to learn the different stitches?

### Activity

1. Make a handkerchief and sew a design with branch stitch, lazy daisy stitch and button box stitch.
2. Make a doll and a flower vase using cotton at home and then submit these.
3. Make a handicraft on your choice made with rejected things.
4. Make a display of the prints of different materials on paper.
5. Draw a mosaic picture using the pieces of color paper.

# Colors and Their Uses

---

## Primary Color (Watercolour)

---



**Yellow**



**Red**



**Blue**

---

## Secondary Color

---



**Orange**



**Green**



**Violet**

---

## Pastel Color

---



**Yellow**



**Red**



**Blue**



**Orange**



**Green**



**Violet**

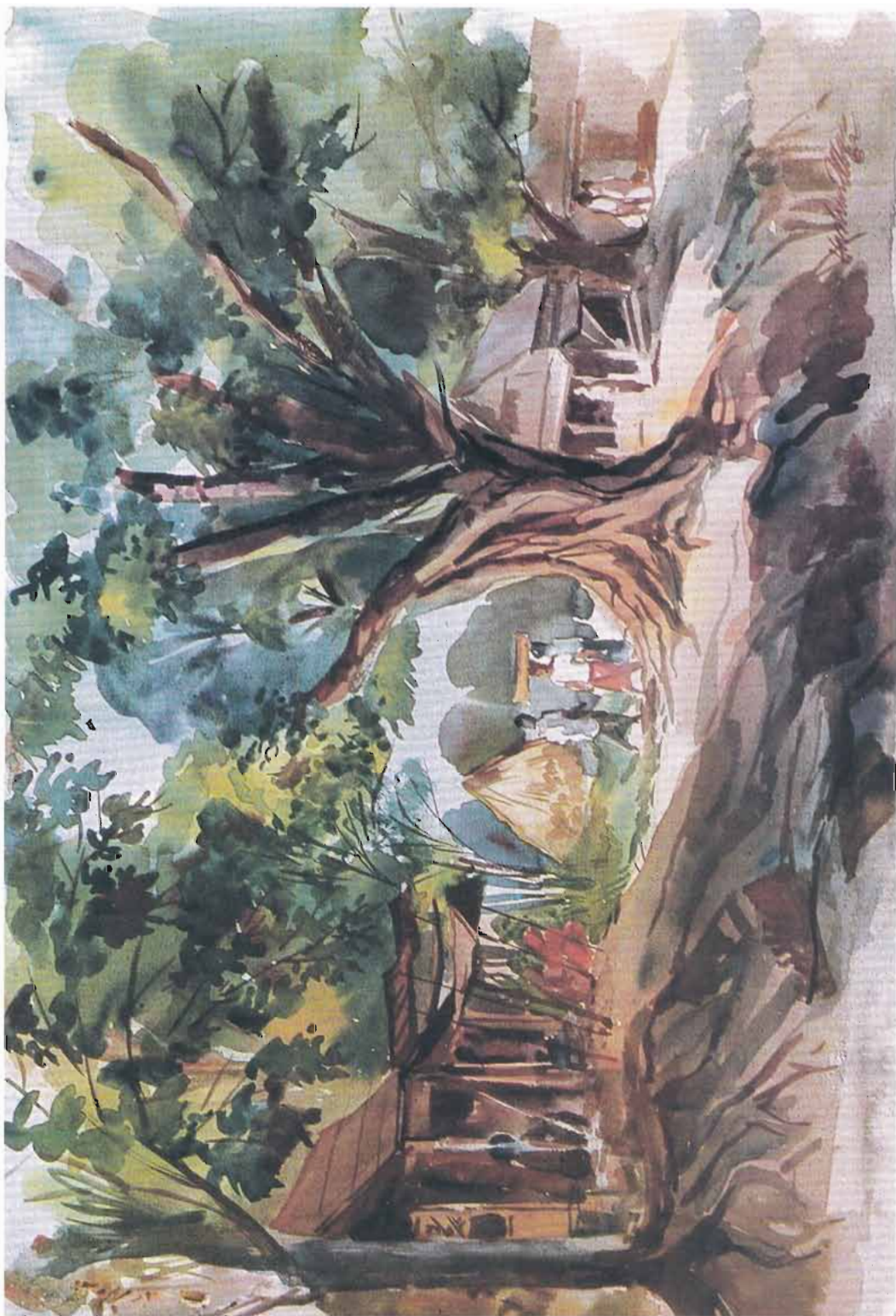

Landscape with watercolor by artist Hashem Khan





“Ahan Manjil” painted in watercolor in 1987 Artist: Sanjeeb Das Apu



Rural life with pastel colour by Tasnia Jaman Muskan



Rural life with watercolour by Md. Shahnewaz





The picture with Poster colour

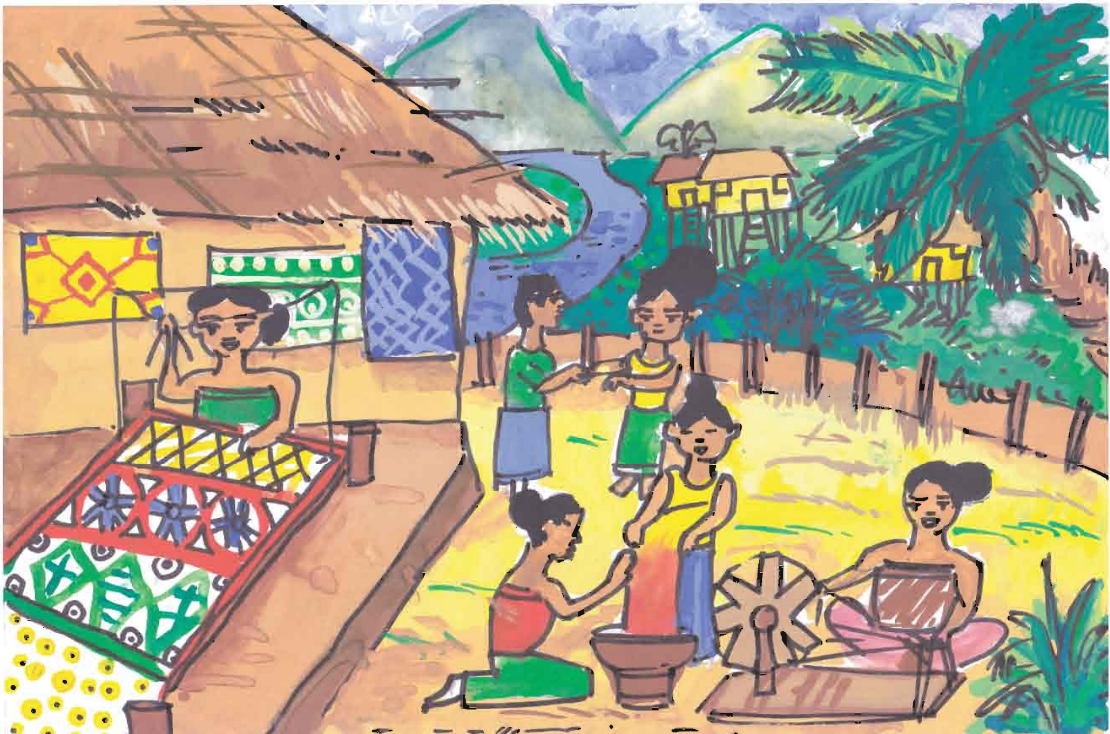

The picture in poster colour is drawn by Ahmed Zudayer Auntu



The painting painted by Suporna Roy 14 years old, using colour acrylic on umbrella



The painting painted by Paramita Shaha 14 years old, using acrylic colour on an umbrella





The harvesting picture drawn by Mahir Ashab Ahon with pastel colour



The picture of baul song festival drawn by Zarif Ahsan Naba with pastel color





Collage work made by different colour paper



The picture drawn by Rusafa Ahmed Mugdha with watercolour

**2019**

**Academic Year**

**7- Arts and Crafts**

সমৃদ্ধ বাংলাদেশ গড়ে তোলার জন্য যোগ্যতা অর্জন কর

– মাননীয় প্রধানমন্ত্রী শেখ হাসিনা

পরামর্শ মানসিক শক্তি বাড়ায়

নারী ও শিশু নির্যাতনের ঘটনা ঘটলে প্রতিকার ও প্রতিরোধের জন্য ন্যাশনাল হেল্পলাইন সেন্টারে  
১০৯ নম্বর-এ (টোল ফ্রি, ২৪ ঘণ্টা সার্ভিস) ফোন করুন



**Ministry of Education**

For free distribution from academic year 2010 by the Government of the  
People's Republic of Bangladesh